

DCS-5605/5635

Version 1.1

**Wireless N/Wired PoE
PTZ H.264 Network Camera**

User Manual

Business Class Networking

Table of Contents

Package Contents	3	Preset Position.....	53
System Requirements	3	Patrol Position.....	54
Introduction	4	Recording.....	55
Hardware Overview	6	Record to SD Card.....	55
Rear	6	Record to Samba Drive.....	55
Front.....	7	Snapshot.....	57
Camera Installation	8	SD Card	60
Installation Wizard	9	Advanced.....	61
Mounting.....	21	ICR.....	61
Using the Camera with a Router.....	24	Digital Output	62
External I/O Port.....		External Trigger Configuration	63
Configuration	25	Maintenance	67
Live Video	26	Admin.....	67
Overview.....	27	Change Password.....	67
Setup	29	Add/Delete User Accounts	67
Internet Connection Setup Wizard.....	30	Device/PT Setting	68
Network Setup	34	Change Camera Name	68
LAN Settings	35	On-Screen Display	68
Port Settings.....	36	Turn On/Off LEDs	68
HTTPS settings	37	Calibrate Device.....	68
Wireless Setup (DCS-5635 only).....	38	System.....	69
Setting up a Wireless Connection with WPS	40	Firmware Upgrade	70
Dynamic DDNS.....	41	Status.....	71
Image Setup.....	42	Device Info	71
Audio and Video.....	44	Log.....	72
Video Profiles.....	44	Help	73
Enable External Speaker	44	Appendix	74
Enable External Microphone	44	Frequently Asked Questions.....	74
Motion Detection	46	How to Ping Your IP Address	77
Drawing Mode	47	Using & Configuring 3G Compatible Cell Phones	78
Motion Detection Setup Wizard.....	48		
Time and Date	52		

Play from RealPlayer	79
Play from PVPlayer	84
Reset and Restore.....	86
Enabling UPnP™ for Windows® XP	87
Technical Specifications.....	91
Contacting Technical Support	93
Warranty	94
Registration.....	97

Package Contents

- D-Link DCS-5605/5635 Wireless N/Wired PoE PTZ H.264 Network Camera
- 12V/2A External Power Adapter
- CAT5 Ethernet Cable
- Quick Install Guide
- CD-ROM
- A/V Cable
- Plate
- Mounting Screws
- 2 Wireless Antennas (DCS-5635 only)

Note: Using a power supply with a different voltage than the one included with the DCS-5605/DCS-5635 will cause damage and void the warranty for this product. If any of the above items are missing, please contact your reseller.

System Requirements

- Internet Explorer 6.0 or higher
- Pentium 4, 2Ghz processor or higher
- 128MB RAM or higher
- 32MB AGP Video Card

Introduction

A HIGH-PERFORMANCE SURVEILLANCE SOLUTION

The DCS-5605/DCS-5635 is a high performance camera for professional surveillance and remote monitoring. This network camera features motorized pan, tilt, and optical/digital zoom for ultimate versatility. The 10x optical zoom lens delivers the level of detail necessary to identify faces, license plate numbers, and other important details that are difficult to clearly distinguish using digital zoom alone.

ADVANCED VIDEO ENCODING

To maximize bandwidth efficiency and improve image quality, the DCS-5605/5635 offers real-time video compression in MJPEG, MPEG-4 and H.264 formats. The H.264 codec can reduce the size of a video stream by up to 80% compared to Motion JPEG. Thus, less network bandwidth and storage space is required.

SURVEILLANCE ON THE GO

The DCS-5605/5635 supports 3GPP mobile surveillance. A live feed from the camera can be accessed on a 3G cellular network using a compatible phone, PDA or mobile device capable of RTSP (Real Time Streaming Protocol) streaming. This enables you to monitor your home or office space in real time even when you are on the go.

THE PERFECT MATCH FOR YOUR NETWORK

Two comparable models are available depending on your unique network requirements. The DCS-5605 includes an Ethernet port, while the DCS-5635 offers both Ethernet and 802.11n wireless interfaces. The wireless model offers installation flexibility and freedom of wireless connectivity in difficult locations without the hassle of running Ethernet cables. The wireless camera supports WEP and WPA-PSK/TKIP for establishing secure connections to your wireless network.

EASY TO INSTALL AND SIMPLE TO MANAGE

The DCS-5605/DCS-5635 can be mounted on a flat surface or with a metal wall mount. You can also set up automated e-mail alerts to be instantly informed of unusual activities. In addition, this network camera supports the Universal Plug-n-Play feature, which allows computers running on Windows® XP/Vista/7 to automatically recognize the camera and add it to the network. Sign up with one of the free Dynamic DNS services available on the web, to assign a name and domain to the camera (for example, mycamera.dlinkddns.com). This way, you may remotely access the camera without having to remember the IP address.

-
- **Supports a Variety of Protocols** -In addition, the DCS-5605/DCS-5635 supports a variety of platforms including FTP, SMTP, NTP, and HTTP. The camera also supports UPnP and DDNS. DDNS allows the camera to use an easier to remember naming format rather than an IP address. UPnP will allow users of Windows® XP to install the camera with the click of a mouse.
 - **Broad Range of Applications** - With today's high-speed Internet services, the Camera can provide the ideal solution for live video images and audio over the Intranet and Internet for remote monitoring. The DCS-5605/DCS-5635 allows remote access from your Internet Explorer Web browser for live image viewing with audio, and allows the administrator to manage and control the Camera anytime and anywhere in the world. Apply the Camera to monitor various objects and places such as homes, offices, banks, hospitals, child-care centers, amusement parks and other varieties of industrial and public monitoring. The Camera can also be used for intruder detection with its motion-detection mode, capture still images and video images for archiving, and many more applications such as sending images to an FTP server or configuring for E-mail alerts. The DCS-5605/DCS-5635 features 2-way Full-Duplex audio with an external microphone (not included) that lets you remotely monitor and record audio with your video. With the addition of optional speakers (not included), you can have 2-way Full-Duplex audio communication with the people you are viewing. The DCS-5605/DCS-5635 also features 10x optical and digital zoom for closer viewing.
 - **A/V Output** -The DCS-5605/DCS-5635 comes with an A/V output allowing you to connect to your TV for local viewing. The DCS-5605/DCS-5635 can also be connected directly to your VCR to record activities.

***Note:** Audio Out from the A/V port is for connecting a speaker to the camera so that a person in front of the camera can hear the person on the other end of the communication. Video out from the A/V port is for connecting to a TV for viewing the camera's video feed or VCR for recording purposes.*

- **Web Configuration** - Using the Internet Explorer Web browser, administrators can configure and manage the Camera directly from its own Web page via the Intranet or the Internet. Up to 20 user names and passwords are permitted, with privilege settings controlled by the administrator.
- **Powerful Surveillance and Remote Monitoring Utility** - Assign an administrator with a pre-defined user ID and password who can modify the Camera settings from the remote site via the Intranet or the Internet. Administrators are allowed to monitor the image, record the image to a hard drive, and take snapshots.
- **Connecting to External Devices** - Supporting auxiliary Input/Output connectors, you can connect the Camera to a variety of external devices such as IR-sensors, switches and alarm relays. Combined with programmable alarming equipments, you can develop a variety of security applications that are triggered on alarm-based events. The Camera provides an industry standard in/out external connector for connectivity.

***Note:** Use of audio or video equipment for recording the image or voice of a person without their knowledge and consent is prohibited in certain states or jurisdictions. Nothing herein represents a warranty or representation that the D-Link product provided herein is suitable for the end-user's intended use under the applicable laws of his or her state. D-Link disclaims any liability whatsoever for any end-user use of the D-Link product, which fails to comply with applicable state, local, or federal laws.*

Hardware Overview

Rear

1	Micro SD Port	Insert a Micro SD memory card to save data from the camera.
2	WPS (DCS-5635 Only)	Press the WPS button to automatically connect to a WPS-enabled wireless router or access point and establish connectivity.
3	Power Receptor	Plug in the supplied power adapter to an outlet.
4	Ethernet Port	Connect an Ethernet cable to a router, switch, or computer. The Ethernet port can also be used to power the camera using a PoE switch (DCS-5605 only).
5	I/O Connector	The camera provides a terminal block with two pairs of connectors situated on the back panel. One pair is for input and the other is for output. The I/O connectors provide the physical interface to send and receive digital signals to a variety of external alarm devices. Please refer to the <i>I/O Connector</i> section in this manual for detailed information.
6	Video/Audio Line-Out Port	Plug the included A/V cable into the A/V out connector to use the camera with a television or VCR, or connect to speakers.
7	External Microphone Port	Insert an external microphone to record audio.
8	Reset Button	Press and hold for 10 seconds to reset the camera back to the default settings.
9	Antenna connector(DCS-5635 Only)	Connects to the wireless antennas



Front



1	Camera Lens	The IR-Cut Removable sensor judges lighting conditions and switches from color to infrared accordingly.
2	WPS/Link LED	The WPS LED will blink blue when initializing a connection, and illuminate with solid blue once the connection has been established (DCS-5635 only). The Link LED will illuminate green once a connection has been established.
3	Microphone	The built-in microphone can be used capture audio from sources nearby the camera.
4	Power LED	The Power LED will illuminate red when the camera is receiving power.

Camera Installation

It is recommended to connect the camera to your computer and configure it before mounting.

Step 1 - Connect an Ethernet cable to the network cable connector located on the DCS-5605/DCS-5635's back panel and attach it to the network.



Step 2 - Attach the supplied power supply to the power input connector located on the DCS-5605/DCS-5635's back panel and connect the other end to your wall outlet.



Installation Wizard

Step 3 - Insert the D-Link CD. When the autorun screen appears, click **Installation Wizard**.



Step 4 - The Welcome screen will appear. Click **Next** to continue.

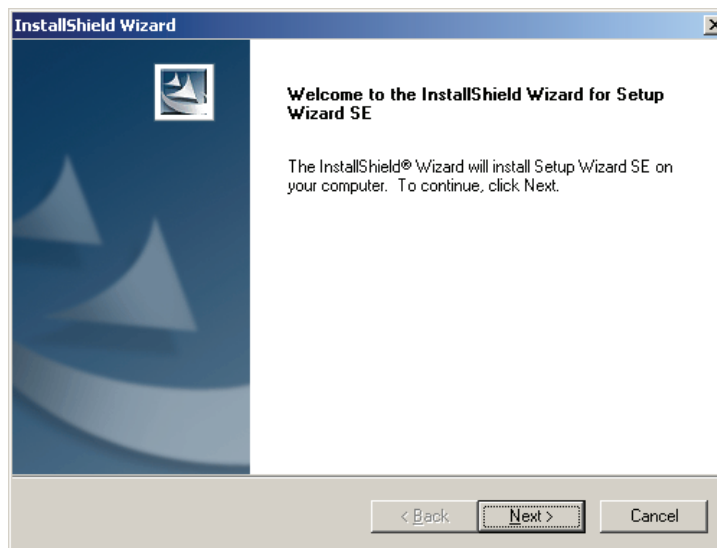

Step 5 - Click **Yes** to the license agreement to continue.

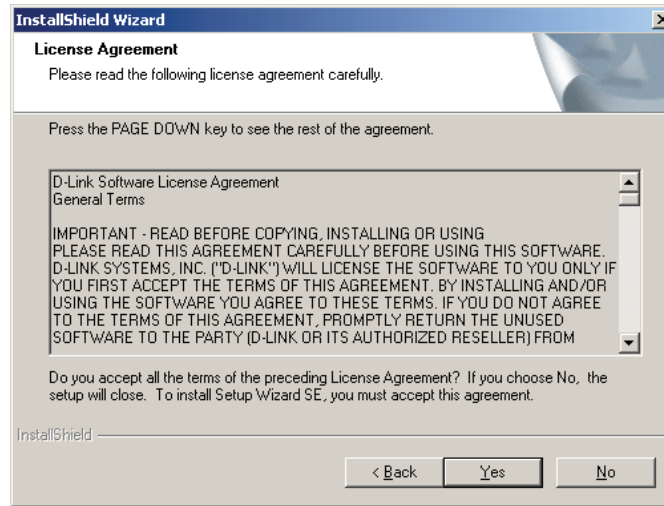

Step 6 - If you do not want to install the wizard into the default location, click **Browse** and select a new folder. Click **Next** to continue.

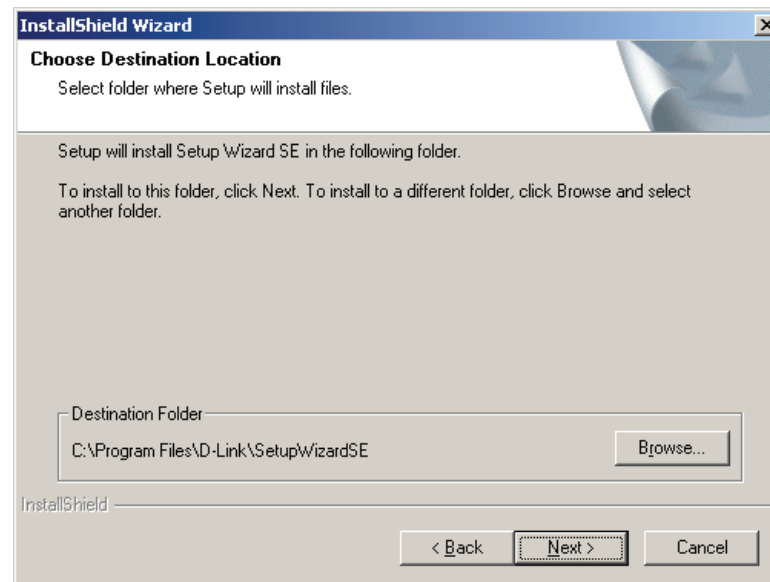

Step 7 - Click **Finish** to complete the installation. Uncheck the **I would like to launch Setup Wizard SE** box if you do not want to run the wizard.

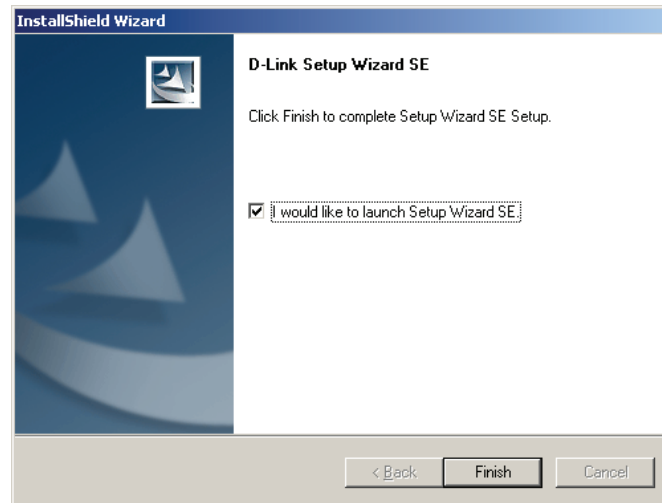

Step 8 - Now, click on **ffdshow** from the autorun screen. This will install the proper codecs that will allow you to playback video taken by the DCS-5605/5635.



Step 9 - Click **I Agree** to the license agreement to continue.

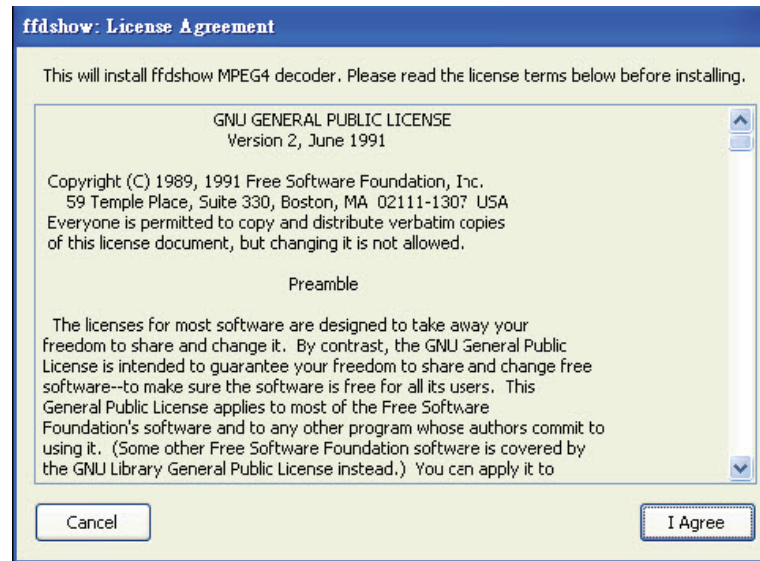

Step 10 - Select your language from the drop-down menu and then click **OK**.

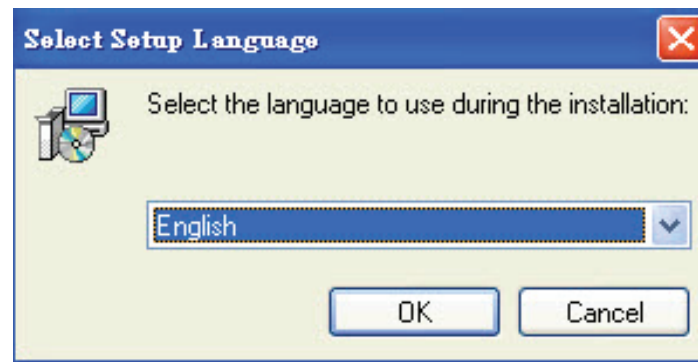

Step 11 - Click **Next** to continue.

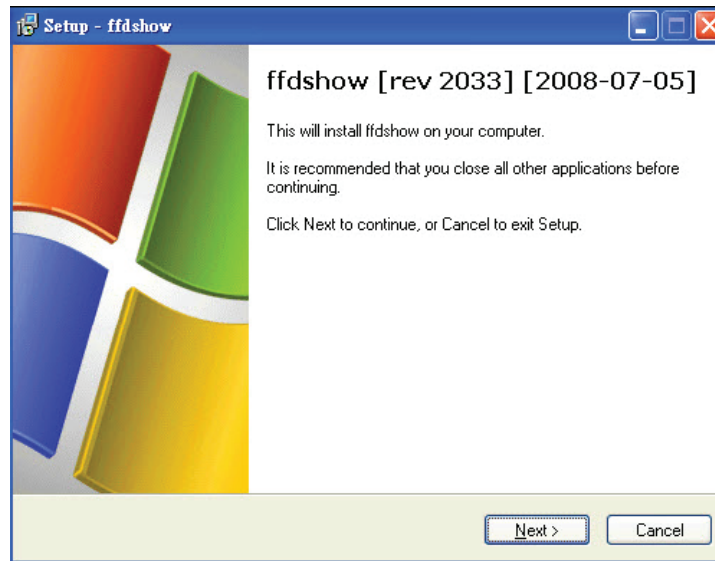

Step 12 - Select the installation location and then click **Next**.

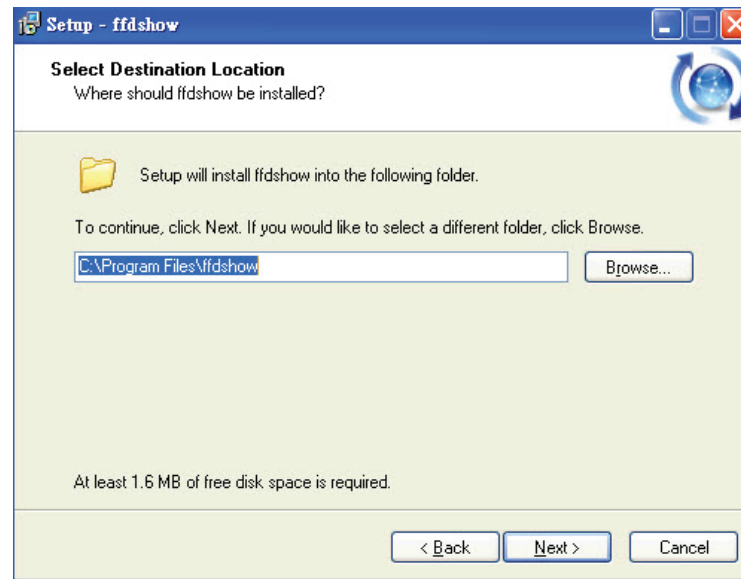

Step 13 - Select the components you want to install and then click **Next** to continue.

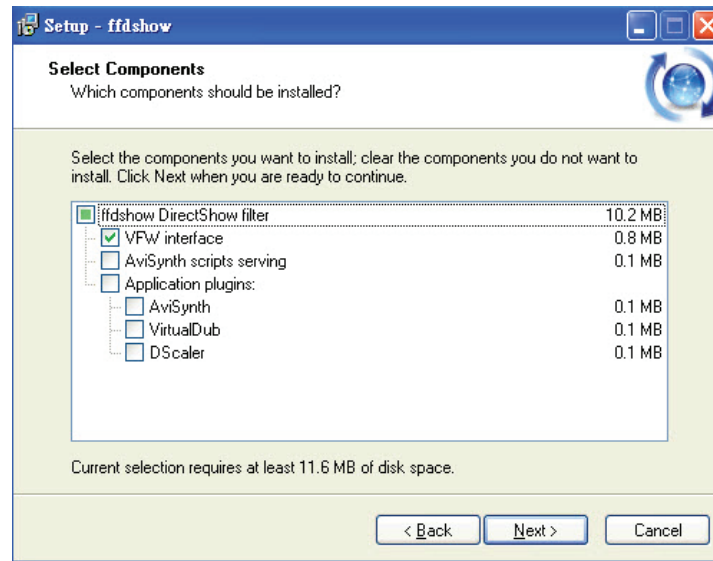

Step 14 - Select the Start Menu folder and then click **Next**.

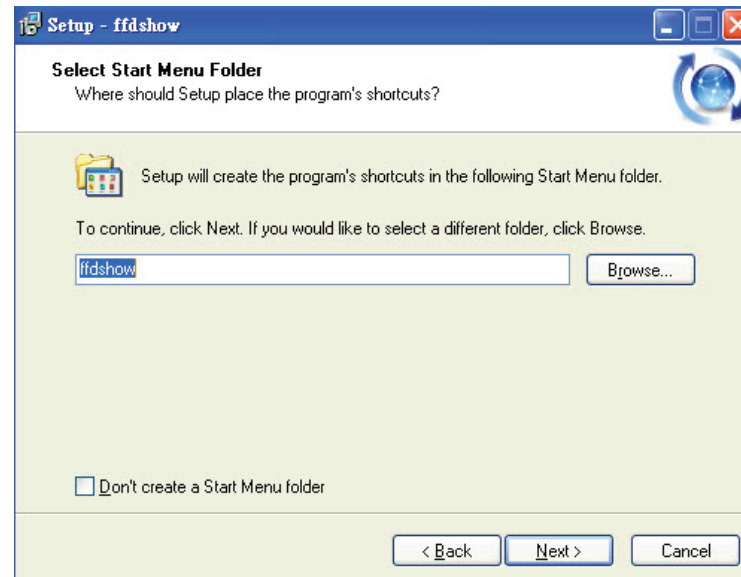

Step 15 - Select the additional tasks you want to perform and then click **Next** to continue.

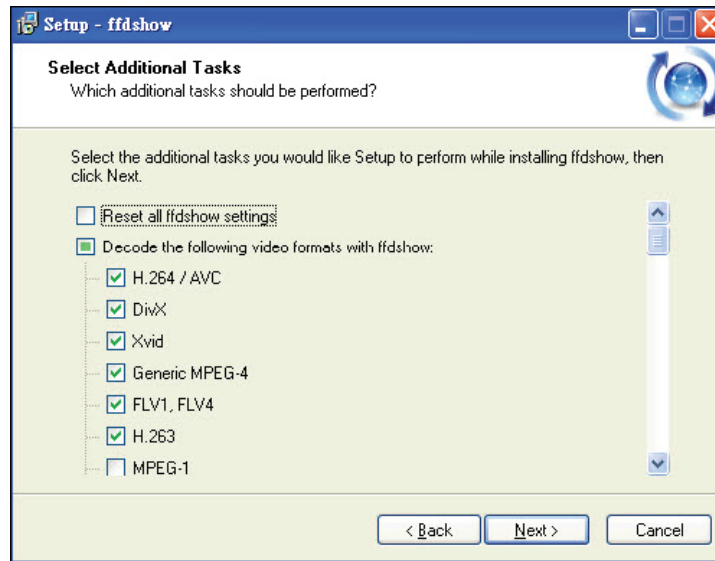

Step 16 - Select the speaker setup on your computer and then click **Next**.

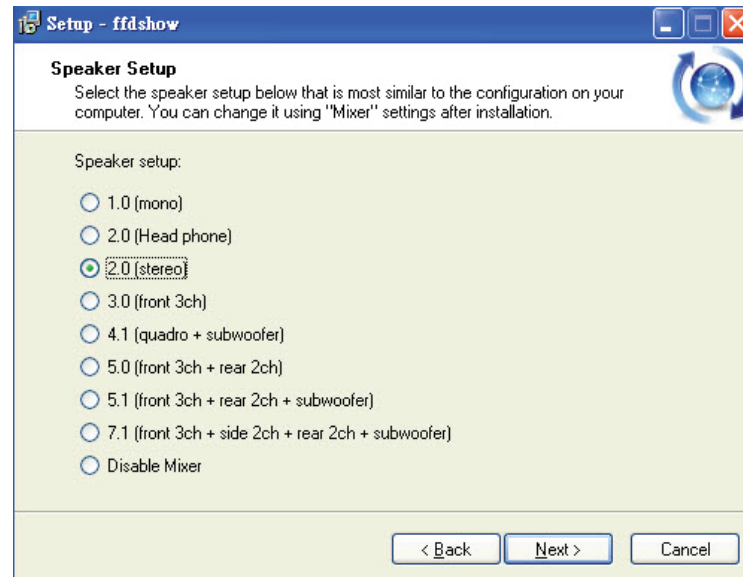

Step 17 - Click **Install** to continue.

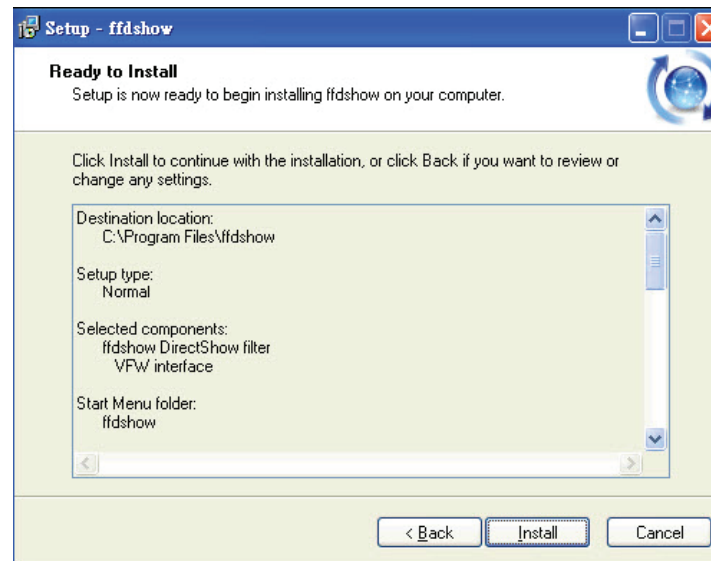

Step 18 - Click **Finish**.



Step 21 - Next to *Admin ID*, enter **admin**. By default the current password is blank. Click the **Change** box and enter a new password (recommended). Click **Next** to continue.



The screenshot shows the 'Set up an Admin ID and Password to secure your camera.' screen. At the top, the D-Link logo and 'SECURICAM Network' are displayed. The main heading reads 'Set up an Admin ID and Password to secure your camera. Click Next to continue.' Below this, there are two columns of input fields. The first column has 'Admin ID' with a text box containing 'admin'. Below it is a 'Change' checkbox, which is checked, followed by 'New ID' and 'Reconfirm' text boxes. The second column has 'Password' with an empty text box. Below it is a 'Change' checkbox, which is checked, followed by 'New Password' and 'Reconfirm' text boxes. At the bottom right, there are three buttons: 'Back' (left arrow), 'Next' (right arrow), and 'Exit' (power icon).

Step 22 - Click **DHCP** to allow your router or DHCP server assign the IP settings to the camera. If you want to manually assign the IP settings, click **Static** and enter the IP address, subnet mask, default gateway, and DNS servers. Click **Next** to continue.



The screenshot shows the 'Set IP Address' screen. At the top, the D-Link logo and 'SECURICAM Network' are displayed. The main heading reads 'Set IP Address'. Below this, there are two radio buttons: 'DHCP' (which is selected) and 'Static IP'. Under 'Static IP', there are five text boxes for 'IP Address', 'Subnet Mask', 'Default Gateway', 'Primary DNS', and 'Secondary DNS'. At the bottom right, there are three buttons: 'Back' (left arrow), 'Next' (right arrow), and 'Exit' (power icon).

Step 23 - If you have the DCS-5635 wireless camera, setup the following wireless settings:

Wireless - Click the **Enable** radio button. If you do not want to use the wireless feature of the camera, click **Disable**.

Connection Mode - Select **Infrastructure** if you are connecting to a wireless router or access point. If you are connecting to a wireless client, select **Adhoc**.

Network Name (SSID) - Enter the SSID or wireless network name. This must be the same name as on your wireless router or access point.

Wireless Channel - If you select **Infrastructure**, select Auto since the wireless router or access point will select the channel automatically.

Authentication - Select **Open, Shared, WPA-PSK, or WPA2-PSK**.

Encryption - Depending on Authentication, select the type of encryption.

Key - Enter the encryption key or passphrase.

Click **Next** to continue.



The screenshot shows the 'Wireless Interface' configuration page for a D-Link Securicam Network. The page has a blue header with the D-Link logo and 'SECURICAM Network' text. The main content area is light gray and contains the following settings:

- Wireless:** Radio buttons for 'Enable' (selected) and 'Disable'.
- Connection mode:** Radio buttons for 'Infrastructure' (selected) and 'Adhoc'.
- Network Name (SSID):** Text input field containing 'dlink'.
- Wireless Channel:** Dropdown menu set to 'Auto'.
- Authentication:** Dropdown menu set to 'WPA-PSK'.
- Encryption:** Dropdown menu set to 'TKIP'.
- Key:** Text input field containing 'mywpassphrase1234'.

At the bottom right, there are three buttons: 'Back' (left arrow), 'Next' (right arrow), and 'Exit' (red square with white 'X').

Step 24 - A summary window will display your settings. Click **Restart** to finish the installation.



The image shows a configuration summary window for a D-Link SECURICAM Network. The window has a blue header with the D-Link logo and the text "SECURICAM Network". Below the header, there are two columns of configuration fields. The left column contains: Admin ID (admin), Password (empty), IP Address (Auto), Subnet Mask (Auto), Default Gateway (Auto), Primary DNS (Auto), and Secondary DNS (Auto). The right column contains: Wireless (Enable), SSID (dlink), Channel (Auto), and Key (mywpapassphrase1). Below the fields, there is a paragraph of text: "Now you have configured all settings. Please click button 'Restart' to commit the settings to the Internet camera and reboot it. Or, you can click button 'Back' to change the settings again." At the bottom right, there are two buttons: "Back" and "Restart".

Admin ID	admin	Wireless	Enable
Password		SSID	dlink
IP Address	Auto	Channel	Auto
Subnet Mask	Auto	Key	mywpapassphrase1
Default Gateway	Auto		
Primary DNS	Auto		
Secondary DNS	Auto		

Now you have configured all settings. Please click button 'Restart' to commit the settings to the Internet camera and reboot it. Or, you can click button 'Back' to change the settings again.

[Back](#) [Restart](#)

Installation is complete. Please refer to page 25 for advanced features of this camera.

Mounting

It is recommended to connect the camera to your computer and configure it before mounting. Refer to the Configuration section.



The holes will be covered but are perforated to be easily removed. Attach the plate to the camera before mounting. Turn the camera clockwise (to the right) until it stops. Read the directions on the next page to mount to a wall or the ceiling.

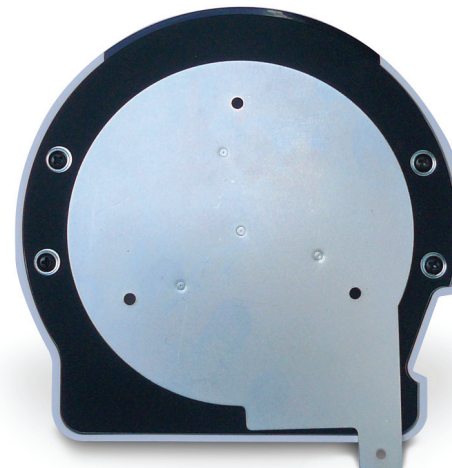
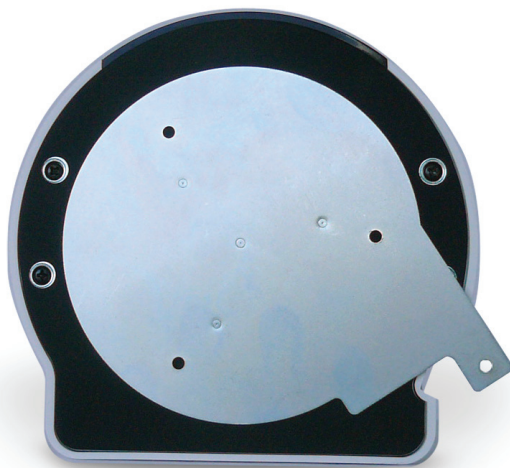

1. Use 3 screws to affix the metal mounting bracket to the ceiling.

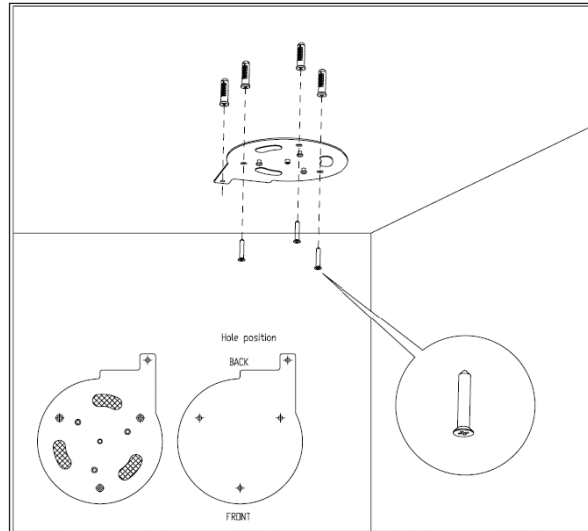

2. Push the camera up onto the metal mounting bracket.

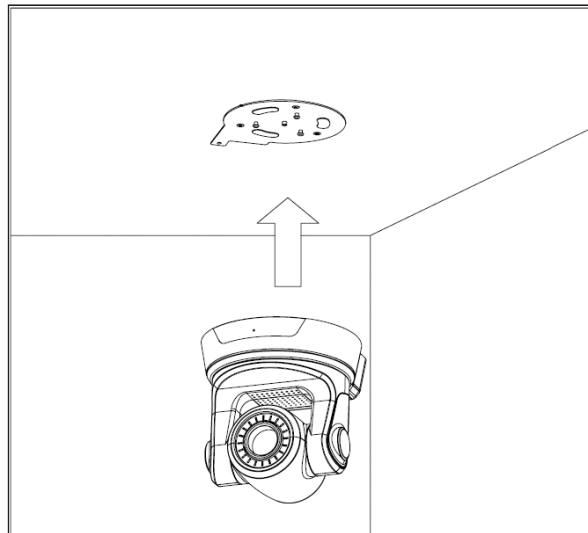

3. Rotate the base of the camera to lock it onto the bracket.

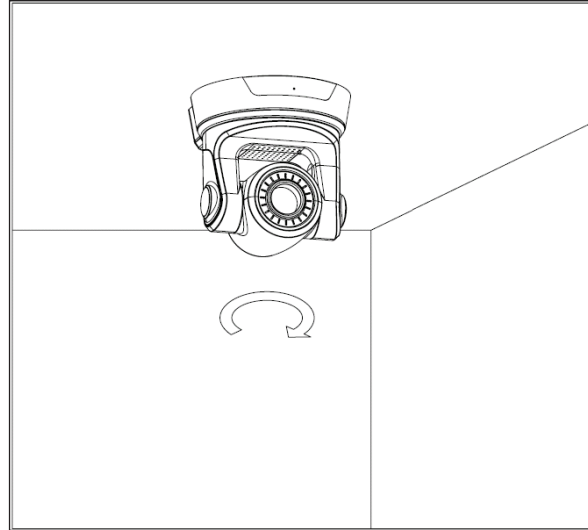

4. Install the final screw so that the camera cannot be removed without the use of a tool.

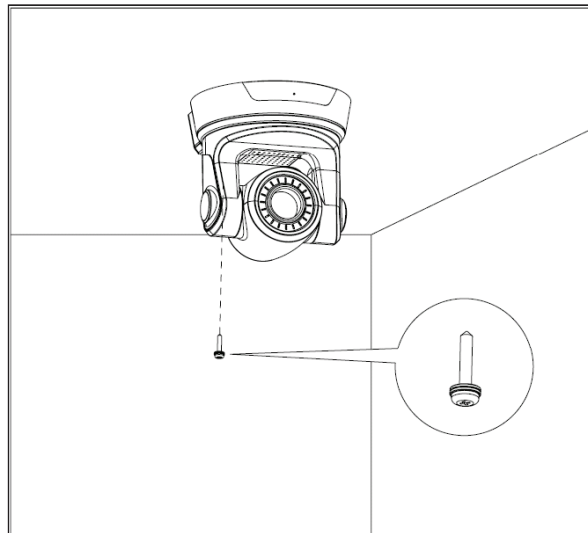

Using the Camera with a Router

If you connect your camera behind a router and want to view video from the Internet, you must open (forward) ports to your camera.

You will need to statically assign the IP address and network information in the camera. Some routers will allow you to set a “reservation” and assign an IP address to the camera automatically. Please refer to your router documentation for more information.

After you have completed the setup of the DCS-5605/DCS-5635 outlined in the **Quick Install Guide** you will have an operating camera that has an assigned IP Address. Because you are using a router to share the Internet with one or more PCs, the IP Address assigned to the camera will be a local IP Address. This allows viewing within your Local Area Network (LAN) until the router is configured to allow remote viewing of the camera over the Internet.

Step 1 - Log into the camera’s web-based configuration by entering its IP address in a web browser such as Internet Explorer.

Step 2 - Enter the username admin and enter your password.

Step 3 - The **Live Video** page will appear. Click the **Setup** tab and then click **Network Setup** on the left side. The following page will appear.

Step 4 - Click **Static IP Address** and then enter the IP Address, Subnet Mask, Default Gateway (usually the IP address of your router), and the DNS servers.

Step 5 - At the bottom, write down the ports listed. If you have more than one camera, you will need to have different port numbers for each. Enter the port numbers and click **Save Settings**.

Step 6 - You must now log into your router and navigate to the page that allows you to open or forward ports. Enter the listed ports and forward to the IP address of your camera.

By default the **HTTP Port** is 80 (TCP) and the **RTSP Port** is 554 (TCP/UDP).

The screenshot shows the D-Link camera's web-based configuration interface. The top navigation bar includes tabs for LIVE VIDEO, SETUP, ADVANCED, MAINTENANCE, STATUS, and HELP. The left sidebar lists various configuration options like Setup Wizard, Network Setup, Wireless Setup, Dynamic DNS, Image Setup, Audio and Video, Motion Detection, Time and Date, Preset Position, Recording, Snapshot, SD Card, and Logout. The main content area is titled 'NETWORK SETUP' and contains sections for 'LAN SETTINGS' and 'PORT DETAIL SETTINGS'. In the 'LAN SETTINGS' section, the 'Static IP Address' option is selected, and the IP Address, Subnet Mask, Default Gateway, Primary DNS, and Secondary DNS fields are highlighted with a red box. In the 'PORT DETAIL SETTINGS' section, the HTTP port is set to 80 and the RTSP port is set to 554, also highlighted with a red box. A 'Helpful Hints...' sidebar on the right provides additional information about DHCP connections and port settings.

Configuration

This section will show you how to configure your new D-Link camera using the web-based configuration utility.

To access the configuration utility, open a web-browser such as Internet Explorer and enter the IP address of the camera (192.168.0.1). If you get a *Page Cannot be Displayed* error, please refer to the **Troubleshooting** section for assistance.

Enter **admin** for the User Name and then enter your password. Leave the password blank by default.

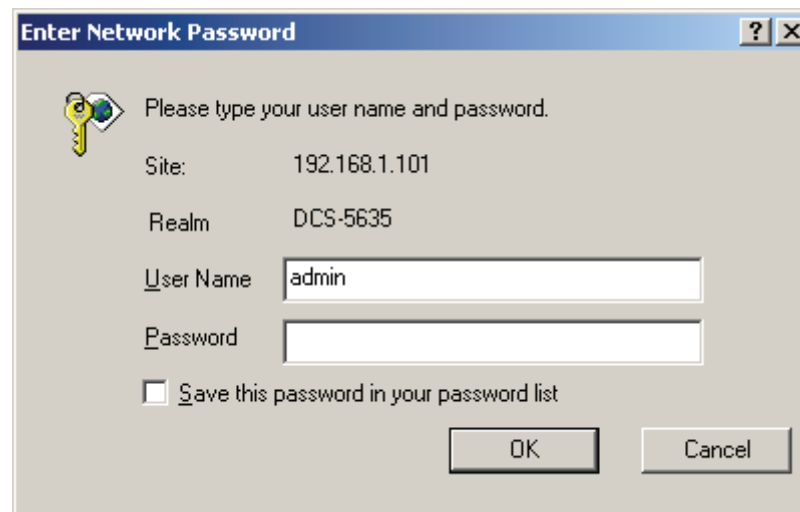

Enter Network Password

Please type your user name and password.

Site: 192.168.1.101

Realm: DCS-5635

User Name: admin

Password:

Save this password in your password list

OK Cancel

Live Video

The image from the DCS-5605/DCS-5635 should be visible from the **Live Video** page on your computer monitor.

Clicking on any part of the image will cause the camera to reposition itself so that the point will be the center of the image.

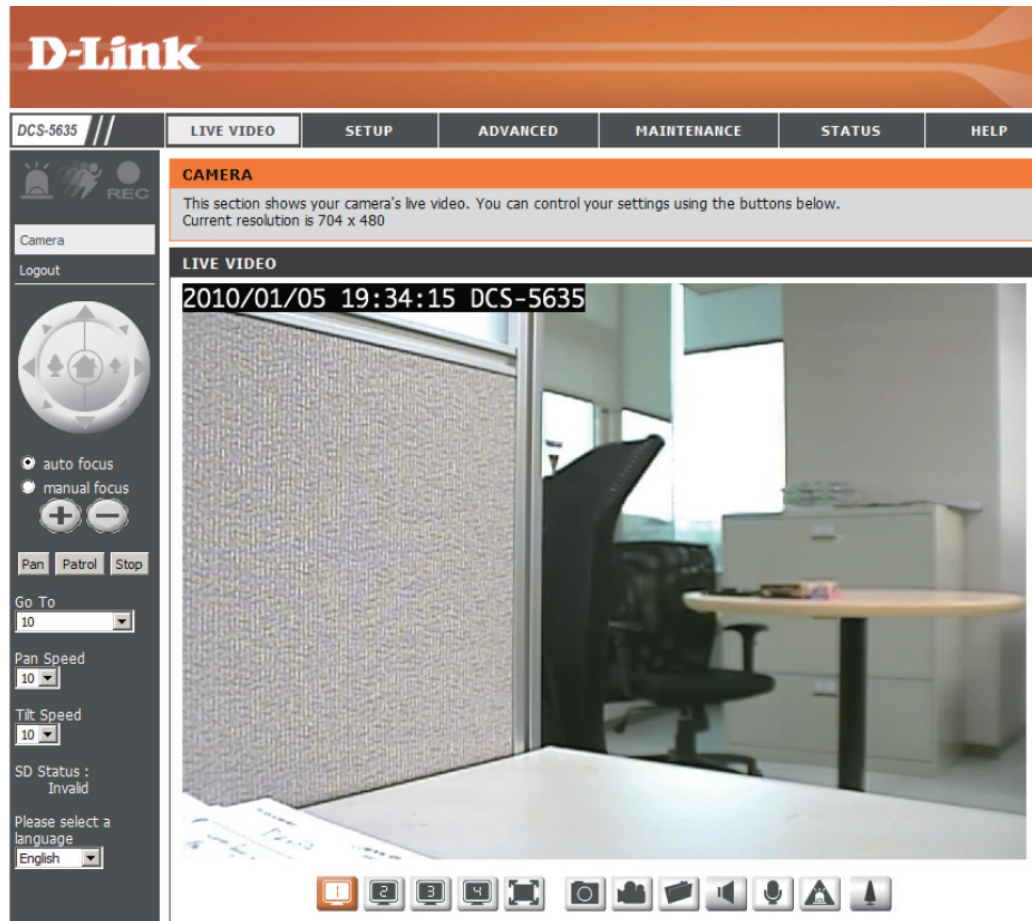

Refer to the next page for an overview of all the options available on this page.

Overview



Outer Ring: Click on the arrows on the outer ring to move the camera. Click the right arrow to move the camera to the right, the up arrow to move the camera up, etc.

Home: Click the **Home** icon to move the camera to its home position.

Inner Ring: Click the left button to zoom in and click the right button to zoom out

Auto Focus: Click to allow the camera to focus automatically (recommended).

Manual Focus: Click to manually focus the camera. Use the - and + buttons to focus in and out.



Pan: Pans the camera one full cycle.

Patrol: Enables the Auto Patrol feature. Please refer to page 53 to configure preset locations.

Stop: Stops movement of the camera during pan.

Go To: Select a preset position from the drop-down menu to move the camera to.

Pan Speed: Select the speed at which the camera will pan (1-10, 10 = fastest).

Tilt Speed: Select the speed at which the camera will tilt (1-10, 10 = fastest).

SD Status: Displays the status of your Micro SD memory card. If you do not have a card inserted into the camera, it will display as **Invalid**.

Language: Select your language from the drop-down menu.

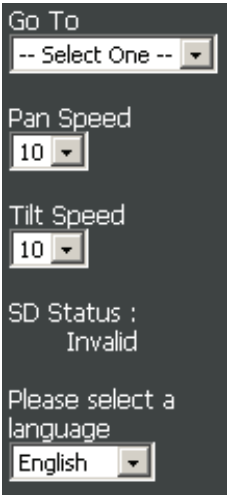

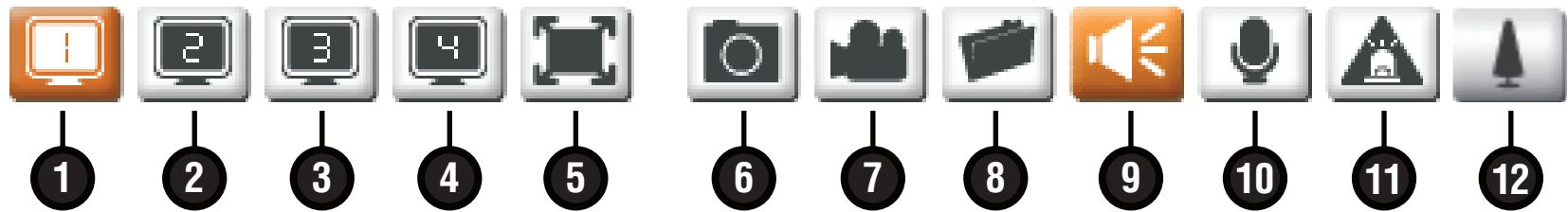

- 1 **Video 1** - Click to use Video Profile 1. You can change the settings in the **Setup > Audio and Video** section.
- 2 **Video 2** - Click to use Video Profile 2. You can change the settings in the **Setup > Audio and Video** section.
- 3 **Video 3** - Click to use Video Profile 3. You can change the settings in the **Setup > Audio and Video** section.
- 4 **Video 4** - Click to use Video Profile 4. You can change the settings in the **Setup > Audio and Video** section.
- 5 **Full Screen** - Click to view video at full screen. Press **ESC** to go back to normal view.
- 6 **Snapshot** - Click to take a snapshot of the current video. The image will pop up in a new window and you may save this image to a local hard drive.
- 7 **Record** - Click to start recording video. Click again to stop recording.
- 8 **Set Path** - Click to select a folder to save video and snapshots.
- 9 **Audio On/Off** - This button toggles the built-in microphone on and off, allowing you to hear audio from the area surrounding your camera. Audio is on by default.
- 10 **Talking On/Off** - This will toggle audio to a speaker (not included) connected to the camera's Audio Out port. This can be used to communicate with others near the camera.
- 11 **Digital Output** - Click to turn on digital output.
- 12 **Digital Zoom** - This button toggles the zoom feature on and off. When zoom is active, you may left click to zoom in or right click to zoom out.

Setup

The screenshot shows the D-Link web interface for the DCS-5635 camera. The top navigation bar includes 'LIVE VIDEO', 'SETUP', 'ADVANCED', 'MAINTENANCE', 'STATUS', and 'HELP'. The 'SETUP' tab is active. On the left, a sidebar lists various setup options: Setup Wizard, Network Setup, Wireless Setup, Dynamic DNS, Image Setup, Audio and Video, Motion Detection, Time and Date, Preset Position, Patrol Position, Recording, Snapshot, SD Card, and Logout. The main content area is divided into two sections: 'Internet connection settings' and 'IP camera motion detection settings'. The 'Internet connection settings' section provides instructions for configuring network settings and offers two options: 'Internet Connection Setup Wizard' and 'Manual Internet Connection Setup'. The 'IP camera motion detection settings' section provides instructions for configuring motion detection and offers two options: 'Motion Detection Setup Wizard' and 'Manual Motion Detection Setup'. A 'Helpful Hints...' sidebar on the right provides additional guidance for advanced users.

Internet Connection Setup Wizard: Click to configure your camera's network settings, Dynamic DNS settings, camera name, and date/time setup.

Setup Wizard: Refer to the next page.

Manual Internet Connection Setup: Click to manually configure your camera. Refer to the **Setup > Network Settings** section.

Motion Detection Setup Wizard: Click to launch the Motion Detection wizard. You will be able to configure detection areas and where to send

Setup Wizard: the images (Email/FTP/folder).

Manual Motion Detection Setup: Click to manually configure motion detection settings. Refer to the **Setup > Motion Detection** section.

Internet Connection Setup Wizard

Click **Next** to continue.

WELCOME TO D-LINK SETUP WIZARD - INTERNET CONNECTION SETUP

This wizard will guide you through a step-by-step process to configure and connect your D-Link Camera to the internet. For your camera motion detection settings, please click Back button to close this wizard and select the Motion Detection Setup Wizard.

- Step 1: LAN Settings
- Step 2: Internet Settings
- Step 3: DDNS Settings
- Step 4: Camera Name Settings
- Step 5: Time Zone

Select **DHCP Connection** to allow a DHCP server (such as a router) to automatically assign the network settings to the camera.

Select **Static IP Address** to manually enter the camera's network settings.

Click **Next** to continue.

STEP 1: LAN SETTINGS

Please select whether your camera will connect to the Internet with a DHCP connection or Static IP address. If your camera is connected to a router, or you are unsure which settings to pick, D-Link recommends that you keep the default selection of DHCP connection. Otherwise, select Static IP address to manually assign an IP address before clicking on the Next button.

DHCP Connection
 Static IP Address

IP Address
Subnet Mask
Default Gateway
Primary DNS
Secondary DNS

If you use the camera to connect directly to the Internet with a PPPoE connection, you will need to enter the username and password, which were given to you when you set up your account with your Internet Service Provider. If the camera is behind a router or a gateway, you do not need to configure this setting.

Click **Next** to continue.

DDNS service synchronizes the public IP address of the modem when it has been modified. The username and password is required when using the DDNS service.

Server Address - Select the web address of your Dynamic DNS service provider.

Host name - The domain name you have applied from DDNS service.

User name - The account name of the DDNS service.

Password - The password for the account of the DDNS service.

Verify Password - Enter your password again used to connect to the DDNS server.

Timeout - You can setup how often the camera notifies the DDNS server of its current global IP address. By default this is 576 hours.

Click **Next** to continue.

STEP 2: INTERNET SETTINGS

If your ISP is using PPPoE, please enable this setting and enter your ISP Username and Password. Then, click on the Next button. Please contact your ISP if you do not know your Username and Password.

Enabled

Username

(e.g. 123456@hinet.net)

Password

Back

Next

Cancel

STEP 3: DDNS SETTINGS

If you have a Dynamic DNS account and would like the camera to update the IP address automatically, please enable DDNS and enter your host information below. Then, click on the Next button to continue.

Enable

Server Address

<<

Select Dynamic DNS Server



Host Name

User Name

Password

Verify Password

Timeout

(Hours)

Back

Next

Cancel

Enter a name for your camera. Click **Next** to continue.

STEP 4: CAMERA NAME SETTINGS

D-Link recommends that you rename your camera for easy accessibility. You can then identify and connect to your camera via this name. Please assign a name of your choice before clicking on the Next button.

Camera Name

Configure the time zone and daylight savings on the camera.

Time Zone - Select your time zone from the drop-down menu.

Auto Daylight Saving - Select to automatically adjusted according to the daylight saving time of the selected time zone.

Set Date and Time Manually - Manually adjust and set the date and time of daylight savings.

Offset - Select the time offset, if your location observes daylight saving time.

Daylight Savings Dates - Sets the dates and time that Daylight Savings begins and ends.

Click **Next** to continue.

STEP 5: TIME ZONE

Please configure the correct time to ensure that all events are triggered, captured and scheduled at the right time. Then, click on the Next button.

Time Zone

Enable Daylight Saving

Auto Daylight Saving

Set date and time manually

Offset

	Month	Week	Day of week	Hour	Minutes
Start time	<input type="text" value="3"/>	<input type="text" value="2"/>	<input type="text" value="Sunday"/>	<input type="text" value="2"/>	<input type="text" value="00"/>
End time	<input type="text" value="11"/>	<input type="text" value="1"/>	<input type="text" value="Sunday"/>	<input type="text" value="2"/>	<input type="text" value="00"/>

Click **Apply** to finish.

STEP 6: SETUP COMPLETE

Click on the Back button to review or modify settings or click on the Apply button if all settings are correct. It is recommended to note down these settings in order to access your camera on the network or via your web browser.

IP Address	DHCP
IP Camera Name	DCS-5635
Time Zone	(GMT-12:00) International Date Line West
DDNS	Disable
PPPoE	Disable

Network Setup

The Network Setup page will allow you to set the IP address, network settings, UPnP, and port information for your camera.

D-Link

DCS-5635 // LIVE VIDEO **SETUP** ADVANCED MAINTENANCE STATUS HELP

Setup Wizard
Network Setup
Wireless Setup
Dynamic DNS
Image Setup
Audio and Video
Motion Detection
Time and Date
Preset Position
Patrol Position
Recording
Snapshot
SD Card
Logout

Network setup
You can configure your LAN and Internet settings here.
Save Settings Don't Save Settings

LAN SETTINGS

LAN

DHCP Connection
 Static IP Address

IP Address: 192.168.0.20
Subnet Mask: 255.255.255.0
Default Gateway: 192.168.0.1
Primary DNS: _____
Secondary DNS: _____

enable UPnP
 enable UPnP port forwarding

External HTTP port: 80
External HTTPS port: 443
External RTSP port: 554

enable PPPoE

User Name: _____
Password: _____
Confirm password: _____

PORT DETAIL SETTINGS

HTTP port: 80
RTSP port: 554
 User authentication

HTTPS SETTINGS

enable HTTPS
 HTTPS only

Country: US
State or province: NY
Locality: NY
Organization: My Com
Organization unit: Planning
Common name: IP Address
Validity: 3650

Save Settings Don't Save Settings

Helpful Hints...
Select 'DHCP Connection' if you are running a DHCP server on your network and would like an IP address assigned to your camera automatically.
- Enabling UPnP settings will allow you to configure your camera as an UPnP device in the network.
- Port Detail Settings allow you to specify the ports you require for both HTTP and RTSP Streaming.
- HTTP Port: is the port you connect to the camera via a standard web browser.
- RTSP Port: is the port you allocate in order to connect to a camera by using streaming mobile devices, such as a mobile phone or PDA.
Enable HTTPS: - Select to enable the HTTP and HTTPS services. By default, this option is enabled.
HTTPS only: - Select this to automatically redirect an HTTP connection to HTTPS.

SURVEILLANCE

LAN Settings

DHCP Connection: Click to allow a DHCP server on your network such as a router to assign your camera IP settings.

Static IP Address: Click to manually enter the network settings of your camera. You will need to enter data in the next 5 boxes.

IP Address: Enter an IP address for your camera. This will be the IP address to access the web-based configuration utility in the future.

Subnet Mask: Enter the subnet mask of your network.

Default Gateway: Enter the gateway IP address. This is usually the IP address of your router.

Primary DNS: Enter the primary DNS server IP address. This is usually the IP address of your router.

Secondary DNS: Enter a secondary DNS server IP address.

Enable UPnP: Check to enable UPnP (Universal Plug and Play). This will allow an icon representing the camera in My Network Places in Windows.

Enable UPnP Port Forwarding: Check to enable UPnP Port Forwarding. If enabled, set the HTTP and RTSP ports below.

External HTTP Port: Enter the HTTP port for the camera. The default port is 80. If you have more than one camera, you must assign different ports on each camera. This port is used to view the camera from the Internet.

External RTSP Port: Enter the RTSP port. The default port is 554. RTSP (Real Time Streaming Protocol) is used for viewing video from a RTSP client. Clients are available for your computer or mobile phone.

LAN SETTINGS

LAN

DHCP Connection
 Static IP Address

IP Address

Subnet Mask

Default Gateway

Primary DNS

Secondary DNS

Enable UPnP
 Enable UPnP port forwarding

External HTTP port

External RTSP port

Enable PPPoE

User Name

Password

Confirm password

Port Settings

PORT DETAIL SETTINGS	
HTTP port	<input type="text" value="80"/>
RTSP port	<input type="text" value="554"/>
	<input type="checkbox"/> User authentication

HTTP Port: Enter the HTTP port for the camera. The default port is 80. If you have more than one camera, you must assign different ports on each camera. This port is used to view the camera from the Internet.

RTSP Port: Enter the RTSP port. The default port is 554. RTSP (Real Time Streaming Protocol) is used for viewing video from a RTSP client. Clients are available for your computer or mobile phone.

User Authentication: Check the **User Authentication** box to force user to enter a user name and password.

Save Settings: Click the **Save Settings** button to save and activate your changes.

HTTPS settings

HTTPS SETTINGS

Enable HTTPS

HTTPS only

Country

State or province

Locality

Organization

Organization unit

Common name

Validity

Enable HTTPS This is default enabled.

HTTPS only Select this will redirect all the HTTP connection to HTTPS pages automatically.

Wireless Setup (DCS-5635 only)

DCS-5635 // LIVE VIDEO SETUP ADVANCED MAINTENANCE STATUS HELP

Setup Wizard
Network Setup
Wireless Setup
Dynamic DNS
Image Setup
Audio and Video
Motion Detection
Time and Date
Preset Position
Recording
Snapshot
SD Card
Logout

wireless setup

In this section, you can setup and configure the wireless settings for your camera.

Save Settings Don't Save Settings

WIRELESS CONFIGURATION

Enable Wireless

Site Survey ===Press Scan Button== Scan

SSID dlink

Wireless Mode Infrastructure

Channel Auto

Authentication Open

Encryption Disable

Key

Save Settings Don't Save Settings

Helpful Hints..

You may choose which wireless network for the connection using the pull-down menu of 'Site Survey' or enter the SSID manually.

SSID (Service Set Identifier) is the name of your wireless network such as Default, Conference, My network, and etc.

Authentication
Open - This option makes the camera visible to all devices on the network. No encryption is provided.
Shared - Allows communication only with other devices that have the identical 'WEP' (Wired Equivalent Privacy) settings.
WPA-PSK, WPA2-PSK - Both modes will require you to input a pre-shared 'Key' for the connection that is held between the camera and the wireless device.

SURVEILLANCE

Enable Wireless: Check the box to enable the wireless features on the camera. If you are not going to use this camera on a wireless network, it is recommended to uncheck this box.

Site Survey: Site survey will display a list of available wireless networks that the camera detects. Click the **Scan** button to search for wireless networks. Once completed, the networks will be available in the drop-down menu. Click on the network you want to connect to. Some of the fields below will automatically be populated with the network's settings.

SSID: If you selected a network from the drop-down menu, the SSID, or name of the wireless network, will be displayed. If you are manually entering the wireless settings, enter the SSID of your network.

Wireless Mode: Select **Infrastructure** (connect to an access point or wireless router) or **Ad-Hoc** (connect directly to a wireless client also in ad-hoc mode).

Channel: Enter the wireless channel of your wireless network. When connecting to an access point or wireless router, this will automatically be set.

Authentication: Select the type of encryption/security. You must know the security settings of your wireless network. If you selected a network from the drop-down menu, this will be automatically set.

Encryption: Select **Enable** or **Disable**. If you selected a network from the drop-down menu, this will be automatically set.

Key: Enter the security key or passphrase.

Save Settings: Click the **Save Settings** button to save and activate your settings. Allow up to 2 minutes to connect to your wireless network.

The image to the right is an example of a wireless setup. After clicking the **Scan** button, a list of networks were displayed in the drop-down menu. The wireless network called **dlink** was selected.

As a result, the following fields were automatically populated:

SSID - dlink

Wireless Mode - Infrastructure

Channel - Auto

Authentication - WPK2-PSK

Encryption - TKIP

To access the network, the user must know the security passphrase used on the network and enter it in the **Key** field.

The signal strength will be display. The value will be between 1 and 100, 100 being the best/strongest signal.

The screenshot shows the D-Link web interface for a DCS-5635 camera. The top navigation bar includes 'LIVE VIDEO', 'SETUP', 'ADVANCED', 'MAINTENANCE', 'STATUS', and 'HELP'. The 'SETUP' tab is active, and the 'Wireless Setup' option is selected in the left sidebar. The main content area is titled 'wireless setup' and contains the following configuration options:

- Enable Wireless:** A checkbox that is currently unchecked.
- Site Survey:** A button labeled 'Scan' next to a dropdown menu showing '===Press Scan Button==='.
- SSID:** A text input field containing 'dlink'.
- Wireless Mode:** A dropdown menu set to 'Infrastructure'.
- Channel:** A dropdown menu set to 'Auto'.
- Authentication:** A dropdown menu set to 'Open'.
- Encryption:** A dropdown menu set to 'Disable'.
- Key:** An empty text input field.

Below the configuration fields are two buttons: 'Save Settings' and 'Don't Save Settings'. On the right side of the interface, there is a 'Helpful Hints..' section with text explaining SSID, Authentication (Open, Shared), and WPA-PSK/WPA2-PSK modes.

Setting up a Wireless Connection with WPS

If your wireless access point or router supports push-button Wireless Protected Setup (WPS), you can quickly configure your wireless network and camera without using the camera's web interface.

After plugging the power adapter to your camera and the front status LED lights up, hold down the WPS button on the back of the camera for 3 seconds. After pressing the button, it should start flashing blue.

Now press the WPS button on your router or access point within 1 minute to activate WPS and allow your devices to automatically configure a wireless connection. After WPS is successfully activated, the WPS LED on your camera will stop flashing, and will light up solid blue, then reboot.

Note: On some routers/access points, you may need to enter the web interface to activate WPS. Consult your product's user manual for further assistance.



Dynamic DDNS

Dynamic DNS (Domain Name Service) is a method of keeping a domain name linked to a changing (dynamic) IP address. With most Cable and DSL connections, you are assigned a dynamic IP address and that address is used only for the duration of that specific connection. With the camera, you can setup your DDNS service and the camera will automatically update your DDNS server every time it receives a different IP address. Depending on the service, this update may take a few hours.

The screenshot shows the D-Link camera's web interface. At the top, there is a navigation bar with the D-Link logo and tabs for LIVE VIDEO, SETUP, ADVANCED, MAINTENANCE, STATUS, and HELP. The SETUP tab is selected. On the left, a sidebar menu lists various setup options, with Dynamic DNS highlighted. The main content area is titled 'Dynamic DNS' and contains an introductory paragraph, a link to sign up for D-Link's Free DDNS service, and two buttons: 'Save Settings' and 'Don't Save Settings'. Below this is a 'DYNAMIC DNS SETTING' section with a form. The form includes a checkbox for 'Enable DDNS', a 'Server Address' field with a drop-down menu, and input fields for 'Host Name', 'User Name', 'Password', and 'Verify Password'. The 'Timeout' is set to 576 hours, and the 'Status' is 'Disable'. There are 'Save Settings' and 'Don't Save Settings' buttons at the bottom of the form. To the right of the form is a 'Helpful Hints...' section with explanatory text. The bottom of the page features a 'SURVEILLANCE' banner.

Enable DDNS: Check the box to enable DDNS on the camera.

Server Address: Enter the DDNS server address or select from the drop-down menu.

Host Name: Enter your DDNS host name.

User Name: Enter your DDNS user name.

Password/Verify: Enter your DDNS password and again to verify.

Timeout: Enter the time (in hours) before the camera will disconnect from the DDNS server.

Status: Displays the current status.

Image Setup

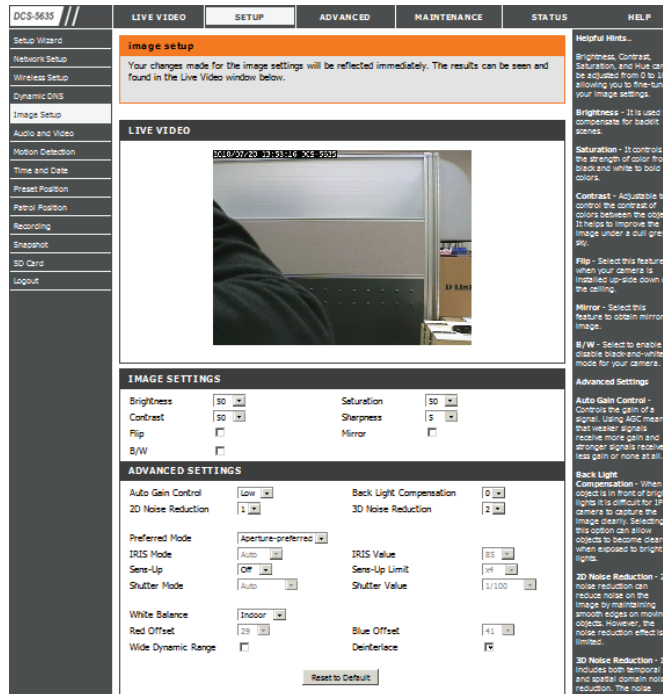

Brightness: Select the brightness level of the video. Higher the value the brighter the image.

Saturation: Select the saturation value. Higher value will make the colors more bold.

Contrast: Select the contrast value.

Sharpness: Select the sharpness value. Lower value will soften the image.

Frequency: Select 50Hz or 60Hz.

Flip: Vertically rotate the video 180°.

Mirror: Horizontally rotate the video 180°. Recommended to select if the camera is installed upside down on the ceiling.

B/W: Change the video to black and white.

Auto Gain Control Controls the gain of a signal. Using AGC means that weaker signals receive more gain and stronger signals receive less gain or none at all.

Back Light Compensation When an object is in front of bright lights it is difficult for IP camera to capture the image clearly. Selecting this option can allow objects to become clearer when exposed to bright lights.

2D Noise Reduction 2D noise reduction can reduce noise on the image by maintaining smooth edges on moving objects. However, the noise reduction effect is limited.

3D Noise Reduction It includes both temporal and spatial domain noise reduction. The noise reduction performance is very high and the gain is programmable. The noise reduction is very powerful for the random and gaussian noise, especially videos from RF signal with noise.

Preferred Mode User can choose “Aperture-preferred”, “Shutter-preferred” or “Manual” for Preferred Mode setting.

IRIS Mod User can choose “Auto” or “Manual” for IRIS Mode setting.

IRIS Value Use this pull-down menu to select an aperture setting in percent when the Auto Iris setting is set to Manual.

Sens-Up If pictures are not clear due to darkness, this SENS-UP operation would increase the sensitivity of picture.

Sens-Up Limit Once “Sens-Up: AUTO” mode is set, the user can configure the SENS-UP limit by increasing/decreasing the shutter speed (e.g.: X2, X4..... X128).

Shutter Mode User can choose “Auto” or “Manual” for Shutter Mode setting.

Shutter Value Select the shutter speed from list box and then the camera will then set the matching aperture value for a proper exposure.

White Balance It is ‘Auto’ by default. It will remove the unrealistic color casts, so that objects which appear white are rendered white in the video.

Indoor color temperature range : 3000~10,500°K

Outdoor color temperature range : 1,800~10,500°K

Red Offset Adjust the Red Level percentage of the image when White Balance is set to Manual.

Blue Offset Blue Offset - Adjust the Blue Level percentage of the image when White Balance is set to Manual.

Wide Dynamic Range The main function of the WDR is to accumulate the scope of contrast between the brightest and darkest points in the picture. With the “On” option, the distribution of brightness values is automatically adapted to the recording scenario.

De-interlace De-interlace - The De-interlacing option helps to improve the image quality. It reduces the effects of interlacing. Click this checkbox to set “de-interlacing on”

Audio and Video

Click the **Audio and Video** button on the left side of the Setup screen to access audio and video settings that affect how the audio and video appears. You may configure 4 video profiles with different settings for your camera. Additionally, you may also configure the audio (speakers and microphone) for your camera. Profile 3 is set as the default profile for snapshots, while profile 4 is the default for a mobile phone or PDA.

The screenshot shows the 'Audio and Video' configuration page for a DCS-5635 camera. The page is organized into three main sections: navigation, settings, and help.

Navigation (Left Sidebar): Includes Setup Wizard, Network Setup, Wireless Setup, Dynamic DNS, Image Setup, Audio and Video (selected), Motion Detection, Time and Date, Preset Position, Patrol Position, Recording, Snapshot, SD Card, and Logout.

Settings (Main Content Area):

- Audio And Video:** Introduction text and 'Save Settings' / 'Don't Save Settings' buttons.
- VIDEO PROFILE 1:** Encode Type: H264, Resolution: 704x576, FPS: 25, bps: 2 Mbps, JPEG Quality: --, RTSP URL: play1.sdp
- VIDEO PROFILE 2:** Encode Type: H264, Resolution: 704x576, FPS: 8, bps: 768 Kbps, JPEG Quality: Good, RTSP URL: play2.sdp
- VIDEO PROFILE 3:** Encode Type: JPEG, Resolution: 704x576, FPS: 8, bps: --, JPEG Quality: Good, RTSP URL: play3.sdp
- VIDEO PROFILE 4 FOR MOBILE DEVICE ONLY:** Encode Type: MPEG4, Resolution: 176x144, FPS: 5, bps: 64 Kbps, JPEG Quality: --, RTSP URL: 3gpp
- AUDIO SETUP:** Enable Speaker: , Volume: 100, Enable Microphone: , Volume: 100

Helpful Hints (Right Sidebar):

- Encode Type:** Select the video codec 'JPEG', 'MPEG4' or 'H264'.
- Resolution:** 3 options depend on display system used.
- FPS (Frame per second):** 30fps is the highest video quality for this camera.
- bps (bit per second):** Select a fixed bandwidth for your camera operation. Higher value means a higher quality image but consumes more network bandwidth.
- JPEG Quality:** Set the quality of JPEG image.
- RTSP URL:** The URL used to connect to the camera when viewing from a mobile device or PDA. (i.e. rtp://EXAMPLE.dlinkddns.com/3gpp).
- Audio Setup:** To switch the external speaker and microphone on/off or adjust the volume.
- Enable Speaker:** Enabling this feature to allow you to talk using PC's microphone and your voice to be transmitted to the external speaker connected to the camera.
- Speaker Volume:** You can adjust the speaker volume using the volume level setting.

Video Profiles (1-4):

Encode Type: Select **H264**, **JPEG**, or **MPEG4** encoding. Profile 4 will always be MPEG4.

Resolution: Select the resolution (size of the viewing area on the screen).

FPS: Select the FPS (Frames per Second). 30 is the maximum (best quality).

BPS: Select the BPS (Bits per Second). This is the fixed bandwidth rate. Higher the value means better quality video but requires more bandwidth.

JPEG Quality: If you selected JPEG as an encoding option, you can select the quality of the video from this drop-down menu.

RTSP URL: This setting allows you to set a suffix for your camera's RTSP URL, so you can view your camera's video with this video profile's settings. For example, if you enter "mpeg4" as your RTSP URL setting and your camera's IP is 192.160.0.30, you can view your camera's video with these settings through 192.160.0.20/mpeg4 .

Note: Video Profile 3 is always set to MJPEG as the Encode Type to ensure that at least one of the Video Profiles are viewable by non-IE browsers. Video Profile 4 is for mobile devices only, and always uses MPEG-4 as the Encode Type.

Enable Speaker: Check to turn on the external speaker. You can use a microphone on your computer to talk through the speaker connected to the camera.

Volume: Change the volume of the external speaker.

Enable Microphone: Checking this box will enable you to listen to audio picked up by the camera's microphone. This will allow you to hear what is happening near your camera.

Volume: This sets the volume level of the incoming audio.

Note: Higher frame size, frame rate and bit rates will give you better video quality, but they will also require more network bandwidth. For best viewing results on a mobile phone, we suggest setting the frame rate to 5 fps and bit rate to 20 Kbps.

After making any changes, click the **Save Settings** button to save your changes, or click the **Don't Save Settings** button to discard your changes.

Save Settings: Click the **Save Settings** button to save and activate your settings.

Motion Detection

D-Link

DCS-5635 // LIVE VIDEO SETUP ADVANCED MAINTENANCE STATUS HELP

motion detection

This section will allow you to enable or disable motion detection function, draw or erase motion area, as well as configure the sensitivity setting of your camera to detect movement. You must select the checkbox of 'Enable Video Motion' to turn on the feature.

Save Settings Don't Save Settings

LIVE VIDEO

Enable Video Motion
2010/07/20 14:07:29 DCS-5635

Sensitivity
90 0~100%

Drawing Mode

Draw motion area
 Erase motion area

Clear

Save Settings Don't Save Settings

Helpful Hints..

Sensitivity - Set the sensitivity of camera to trigger motion detection. High sensitivity makes the motions easier to be detected.

Draw motion area - Drag your mouse to add motion detection range.

Erase motion area - Drag your mouse to erase motion detection range.

Enable Motion Detection: Check the box to enable motion detection. This will allow the camera to serve as a security device by recording only when motion is detected.

Sensitivity: Specify how much movement is required to trigger the motion detection. Refer to the next page to set up the trigger area.

Drawing Mode

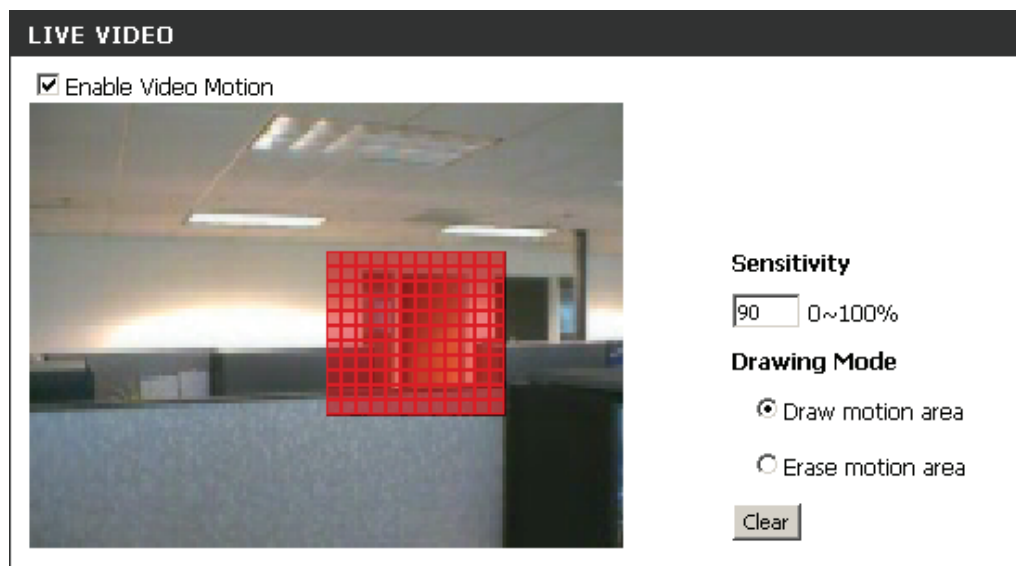

Draw Motion Area: Select to draw a motion area.

Erase Motion Area: Select to use the mouse to remove motion areas.

Clear: Click the **Clear** button to remove all drawing areas.

Save Settings: Click the **Save Settings** button to save and activate your settings.

The red grid indicates an area that has been selected for motion detection. When motion is detected, the LIVE VIDEO page will display a blinking orange motion video icon like the one below.



Motion

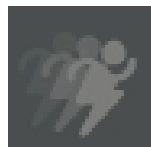

No Motion

Note: The motion notification will continue to blink as long as motion is detected. If no additional motion is detected, it will return to its original state after eight seconds.

Motion Detection Setup Wizard

To run the Motion Detection Setup Wizard, log into the camera's web-based configuration and click the **Setup** tab.

Click the **Motion Detection Setup Wizard** button.

D-Link

DCS-5635 // LIVE VIDEO **SETUP** ADVANCED MAINTENANCE STATUS HELP

Setup Wizard
Network Setup
Wireless Setup
Dynamic DNS
Image Setup
Audio and Video
Motion Detection
Time and Date
Preset Position
Patrol Position
Recording
Snapshot
SD Card
Logout

internet connection settings

In this section, you can setup the IP camera's network interface settings. If you are configuring this device for the first time, D-Link recommends that you select the Internet Connection Setup Wizard, and follow the instructions on screen. If you wish to modify or configure the IP camera settings manually, you may select the Manual Internet Connection Setup to input the network setting.

Internet Connection Setup Wizard Manual Internet Connection Setup

IP camera motion detection settings

In this section, you can setup the IP camera's Motion Detection settings. If you are configuring this device for the first time, D-Link recommends that you select the Motion Detection Setup Wizard, and follow the instructions on screen. If you wish to modify or configure the Motion Detection manually, select the Manual Motion Detection Setup.

Motion Detection Setup Wizard Manual Motion Detection Setup

Helpful Hints..

If you are an advanced user and have configured an Internet camera before, click 'Manual Internet Connection Setup' to input all settings manually.

If you consider yourself an advanced user and you want to manually set up motion detection settings, click 'Manual Motion Detection Setup' to input all the settings manually.

SURVEILLANCE

Click **Next** to continue.

WELCOME TO D-LINK SETUP WIZARD - MOTION DETECTION

This wizard will guide you through a step-by-step process to configure your camera's motion detection functions. To setup the camera LAN or Internet settings, please click on the Back button to close this wizard and re-open the Internet Connection Setup Wizard. Otherwise click on the Next button to begin.

- Step 1: Specify Motion Detection Area Settings
- Step 2: Alerts and Notifications

Back Next Cancel

Click the **Enable Video Motion** box.

To draw an area, click the **Draw Motion Area** button and click on the area on the screen where you want to detect motion. In the example to the right, the red box is over a door. If there is any motion in the door way, the camera will email a user and/or record the activity.

To remove any of the area (red boxes), click the **Erase Motion Area** and click the red boxes you want to remove.

To remove all motion areas, click the **Clear** button.

Click **Next** to continue.

STEP 1: SPECIFY MOTION DETECTION AREA SETTINGS

This section will allow you to enable or disable motion detection function, draw or erase motion area, as well as configure the sensitivity setting of your camera to detect movement.

Enable Video Motion

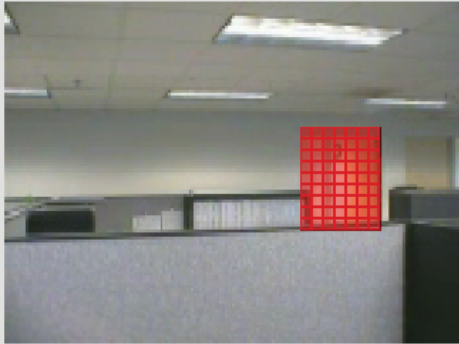

Sensitivity
90 0~100%

Drawing Mode

Draw motion area
 Erase motion area

Clear

Back Next Cancel

E-mail Address: If you select the option, the current still image is captured and an E-mail with the captured image file attached is sent to the recipient E-mail address.

User Name: This will be the username that was given by your ISP (Internet Service Provider). This could be smith or smith@yourisp.com depending on your particular ISP.

Password: The password that you set up to view your e-mail account.

SMTP Mail Server: The host name of the e-mail server (For example smtpserver.yourdomain.com).

Sender E-mail Address: The sender's email address that appears in the email alert (For example smith@isp.com). Notification will be sent to this email address if the e-mails failed to be delivered to the recipient email address.

STEP 2: ALERTS AND NOTIFICATIONS

This final step allows you to specify how you will receive alert and notification of camera events. You can enable an email notification and/or a FTP Notification by input all the relevant information. Then, click on the Next button.

Enable e-mail notification

User Name

Password

SMTP Mail Server

Sender E-mail Address

Recipient E-mail Address

Port

Enable FTP uploading

User Name

Password

Host Name

Path

Filename Prefix

Port

Interval Seconds (range 1 to 86400 seconds)

Passive Mode

Back Next Cancel

Recipient E-mail Address: This is the email address that will receive all the captured images.

Port: This is the port that your email SMTP service is running on. Default is 25.

FTP Server: Send a snapshot to FTP Server.

User Name: The account name to access the FTP server.

Password: The password that was setup with the account to access the FTP server.

Host Name: The host name or IP Address of the FTP server. (i.e. ftp.dlink.com)

Path: The directory that the images will be uploaded into (For example, \pub\images).

Filename Prefix: The prefix that will be added to the front of each filename.

Port: The port of the FTP server. Most FTP servers are running at the default port (21).

Interval: The time interval between each snapshot.

Passive Mode: Some FTP servers allow clients to use passive mode when connecting to an FTP, which uses random ports for transfers.

Once you are finished entering the requested information, click **Apply** to finish the wizard.

STEP 3: SETUP COMPLETE

You have completed your camera setup. Please click the Back button if you want to review or modify your settings or click on the Apply button to save and apply your settings.

Motion Detection: Enable

Alerts and Notification: Do not notify me

Time and Date

The screenshot shows the D-Link DCS-5635 camera web interface. The top navigation bar includes 'LIVE VIDEO', 'SETUP', 'ADVANCED', 'MAINTENANCE', 'STATUS', and 'HELP'. The left sidebar lists various setup options, with 'Time and Date' selected. The main content area is titled 'Time and Date' and contains the following sections:

- Time and Date:** A header section with the text 'Here you may configure the internal clock of your camera.' and 'Save Settings' / 'Don't Save Settings' buttons.
- TIME CONFIGURATION:** A section with a 'Time' dropdown menu, a 'Zone' dropdown menu (set to '(GMT-12:00) International Date Line West'), and an 'Enable Daylight Saving' checkbox (checked). Below this are radio buttons for 'Auto Daylight Saving' (selected) and 'Set date and time manually'. The 'Set date and time manually' section includes an 'Offset' dropdown (set to '+1:00') and a table for 'Start time' and 'End time' with columns for Month, Week, Day of week, Hour, and Minutes.
- AUTOMATIC TIME CONFIGURATION:** A section with a 'Synchronize with NTP Server' checkbox (unchecked) and an 'NTP Server' dropdown menu (set to '<< Select NTP Server').
- SET DATE AND TIME MANUALLY:** A section with a 'Set date and time manually' checkbox (unchecked) and a grid of dropdown menus for Year, Month, Day, Hour, Minute, and Second. A 'Copy Your Computer's Time Settings' button is located below the grid.

At the bottom of the main content area are 'Save Settings' and 'Don't Save Settings' buttons. The bottom of the page features the 'SURVEILLANCE' logo.

Time Zone: Select your time zone from the drop-down menu.

Enable Daylight Savings: Check to enable Daylight Savings. You can select **Auto Daylight Time** to automatically change or select **Set Date and Time Manually** to enter the information.

Synchronize with NTP Server: Select to synchronize with a NTP time server on the Internet. Enter the NTP server URL or IP address, or select a time server from the drop-down menu.

Set Day and Time Manually: Select to manually enter the date and time.

Copy your Computer's Time settings: Click to synchronize the time and date with the computer you are currently logged into the camera with.

Preset Position

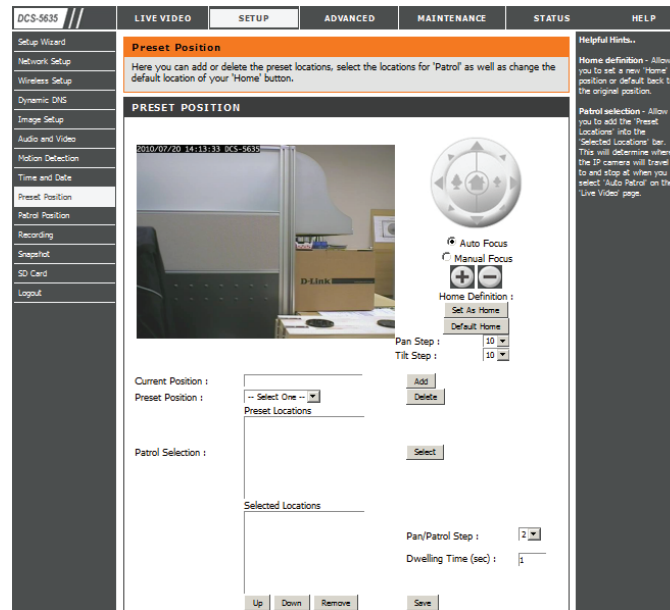

Set as Home: Click to set the current camera position as **Home**.

Default Home: Click to set **Home** to the default camera position.

Pan Speed: Change the pan speed from the drop-down (1-10, 10 = fastest).

Tilt Speed: Change the tilt speed from the drop-down (1-10, 10 = fastest).

Current Position: Once you move the camera to a position you like, enter a name for the location and then click **Add**.

Patrol Selection: Allows you to add saved locations from the *Preset Locations* box into the *Selected Locations* box. This will determine where the camera will travel to and stop at when you select **Auto Patrol** on the *Live Video* page.

Pan/Patrol Speed: The Pan/Patrol Speed control applies only when using the Pan and Patrol buttons in the live video interface.

Dwelling Time: Specify the number of seconds that the camera should remain fixed upon a specified preset position.

Patrol Position

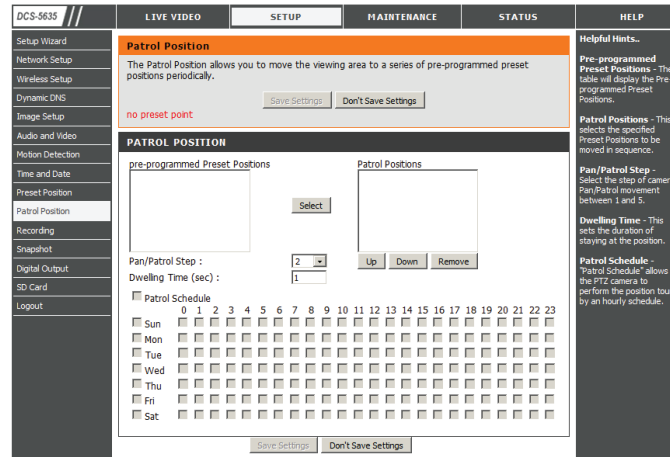

Pre-programmed Preset Positions: The table will display the Pre-programmed Preset Positions.

Patrol Positions: This selects the specified Preset Positions to be moved in sequence.

Pan/Patrol Step: Select the step of camera Pan/Patrol movement between 1 and 5.

Dwelling Time: This sets the duration of staying at the position.

Patrol Schedule: "Patrol Schedule" allows the PTZ camera to perform the position tour by an hourly schedule.

Recording

D-Link

DCS-5635 // LIVE VIDEO SETUP ADVANCED MAINTENANCE STATUS HELP

RECORDING

Here you may configure and schedule the recording of you camera. You must select the checkbox of 'Enable Recording' to turn on the feature.

Save Settings Don't Save Settings

RECORDING

Enable recording

Record to

SD Card

SD Card status : Disable [Get status](#)

Samba network drive

Samba Auth [Anonymous](#)

User name

Password

Password confirm

Server

Shared folder

[Test](#)

Samba status : Disable [Get status](#)

Recording Options

Resolution [profile 1](#)

Record until MB of free space is left (minimum is 32MB)

When storage is full:

Stop recording

Overwrite older recordings

Recording Method

Event Based

Motion detection triggered recording

Digital input 1 triggered recording

Prerecord seconds (range 0 to 15 seconds)

Postrecord seconds (range 0 to 15 seconds)

Continuous (Samba only)

Scheduled (Samba only)

		Hours	Minutes	Hours	Minutes
<input checked="" type="checkbox"/> Sun	Start	<input type="text"/>	<input type="text"/>	End	<input type="text"/>
<input checked="" type="checkbox"/> Mon	Start	<input type="text"/>	<input type="text"/>	End	<input type="text"/>
<input checked="" type="checkbox"/> Tue	Start	<input type="text"/>	<input type="text"/>	End	<input type="text"/>
<input checked="" type="checkbox"/> Wed	Start	<input type="text"/>	<input type="text"/>	End	<input type="text"/>
<input checked="" type="checkbox"/> Thu	Start	<input type="text"/>	<input type="text"/>	End	<input type="text"/>
<input checked="" type="checkbox"/> Fri	Start	<input type="text"/>	<input type="text"/>	End	<input type="text"/>
<input checked="" type="checkbox"/> Sat	Start	<input type="text"/>	<input type="text"/>	End	<input type="text"/>

Save Settings Don't Save Settings

Helpful Hints..

You can record the video to a SD Card or a Samba network drive based on the selected events. You may also configure the 'Recording Options' and select a scheduling method to specify when the camera will record video.

SURVEILLANCE

Enable Recording: Check to enable the recording function.

SD Card: Select to record to an inserted Micro SD memory card.

Samba Network Drive: Select to use Samba.

Samba Auth: Select the type of authentication from the drop-down menu.

User Name: Enter your Samba user name.

Password/Confirm: Enter your Samba password and again to confirm it.

Server: Enter the URL or IP address of the Samba drive.

Shared Folder: Enter the shared folder name.

Test: Click **Test** to verify your settings are correct.

Resolution: Select the profile from the drop-down menu. Refer to the **Audio and Video** section for more information on profiles.

Record until: Enter the amount of space left on your hard drive before the camera stops recording. Must be at least 32MB.

When Storage is Full: Select **Stop Recording** to stop when you are out of hard drive space, specified in the **Record until...** option above; or select **Overwrite older recordings** to have the camera continue recording but will overwrite old data.

Event Based: Select the **Motion detection triggered recording** option to start recording when there is motion detected.

Prerecord Seconds: With the prerecord setting, the camera begin recording for a preset amount of time before motion was triggered is recorded to the drive.

Postrecord Seconds: This setting enables the camera to record after a motion detection event has occurred. It records for a preset amount of time after the event has been triggered, even though the motion may have ceased.

Scheduled: You can program recording to turn on and off at specific time each day.

Continuous: Select this option to record video all the time (Samba only).

Scheduled: Select this option to record video based on the scheduled period of time (Samba only).

Snapshot

DCS-5635
LIVE VIDEO
SETUP
ADVANCED
MAINTENANCE
STATUS
HELP

- Setup Wizard
- Network Setup
- Wireless Setup
- Dynamic DNS
- Image Setup
- Audio and Video
- Motion Detection
- Time and Date
- Privacy Position
- Patrol Position
- Recording
- Snapshot**
- SD Card
- Logout

Snapshot

In order to enable your camera to take snapshots, you must select the checkbox of Enable Snapshot. Then, you can determine the trigger event(s) and FTP and/or email notification(s). The resolution of snapshot can be configured as in the video profile 3 in [Audio And Video](#).

SNAPSHOT

Enable Snapshot

Scheduling

Event Based

Motion Detection

D/I Signal

Continuous (FTP only)

Scheduled (FTP only)

		Hours	Minutes	Hours	Minutes
<input checked="" type="checkbox"/> Sun	Start	<input type="text" value="00"/>	<input type="text" value="00"/>	End	<input type="text" value="24"/> : <input type="text" value="00"/>
<input checked="" type="checkbox"/> Mon	Start	<input type="text" value="00"/>	<input type="text" value="00"/>	End	<input type="text" value="24"/> : <input type="text" value="00"/>
<input checked="" type="checkbox"/> Tue	Start	<input type="text" value="00"/>	<input type="text" value="00"/>	End	<input type="text" value="24"/> : <input type="text" value="00"/>
<input type="checkbox"/> Wed	Start	<input type="text" value="00"/>	<input type="text" value="00"/>	End	<input type="text" value="24"/> : <input type="text" value="00"/>
<input type="checkbox"/> Thu	Start	<input type="text" value="00"/>	<input type="text" value="00"/>	End	<input type="text" value="24"/> : <input type="text" value="00"/>
<input type="checkbox"/> Fri	Start	<input type="text" value="00"/>	<input type="text" value="00"/>	End	<input type="text" value="24"/> : <input type="text" value="00"/>
<input type="checkbox"/> Sat	Start	<input type="text" value="00"/>	<input type="text" value="00"/>	End	<input type="text" value="24"/> : <input type="text" value="00"/>

Send to:

E-mail Address

User Name

Password

SMTP Mail Server

Sender E-mail Address

Recipient E-mail Address

Port (range 1 to 65535)

Use authentication

Use TLS None SSL/TLS TLS/STARTTLS

FTP Server

User Name

Password

Host Name

Path

Filename Prefix

Port (range 1 to 65535)

Interval Seconds (range 1 to 86400 seconds)

Passive Mode

Helpful Hints...

You can choose to receive notifications by FTP and/or E-mail. The "Test" buttons are provided to test if your input settings are valid and functional. IP Camera can send the snapshot images to a recipient E-mail address. To specify multiple recipients for the sender E-mail Address, simply separate each recipient with a semicolon. For example: user1@isp.com; user2@isp.com; user3@isp.com; user4@isp.com; user5@isp.com.

Snapshot

Enable Snapshot: When select the option, you can send a still image from this unit as an attachment of an E-mail or to an FTP server.

Trigger Event: Select the **Motion Detection** option to transfers images to the specified FTP site or E-Mail address when there are motions detected. Select the **D/I Signal 1** option to transfers images to the specified FTP site or E-Mail address when Digital Input 1 is active.

Continuous (FTP Only): Select this option to record snapshots all the time.

Scheduled (FTP Only): Select this option to record snapshots based on the specified time period.

E-Mail Setting

E-mail Address: If you select the option, the current still image is captured and an E-mail with the captured image file attached is sent to the recipient E-mail address.

User Name: This will be the username that was given by your ISP (Internet Service Provider). This could be smith or smith@yourisp.com depending on your particular ISP.

Password: The password that you set up to view your e-mail account.

SMTP Mail Server: The host name of the e-mail server (for example, smtpserver.yourdomain.com).

Sender E-mail Address: The sender's email address that appears in the email alert (for example, smith@isp.com). Notification will be sent to this email address if the e-mails failed to be delivered to the recipient email address.

Recipient E-mail Address: This is the email address that will receive all the captured images.

Port: This is the port that your email SMTP service is running on. Default is 25.

TLS/SSL: These two protocols (SSL is succeeded by TLS) are cryptographic protocols that provide secure communication on a network.

FTP Setting

FTP Server: Send a snapshot to FTP Server.

User Name: The account name to access the FTP server.

Password: The password that was setup with the account to access the FTP server.

Host Name: The host name or IP address of the FTP server. (i.e. ftp.dlink.com)

Path: The directory that the images will be uploaded into (For example, \pub\images).

Filename Prefix: The prefix that will be added to the front of each filename.

Port: The port of the FTP server. Most FTP servers are running at the default port (21).

Interval: The time interval between each snapshots.

Passive Mode: Some FTP servers allow clients to use passive mode when connecting to an FTP, which uses random ports for transfers.

SD Card

SD Status: The status of the Micro SD memory card will be displayed.

Format SD Card: Click to format the Micro SD memory card. This will delete all data on your card.

View Recorded Picture: If the picture files are stored on the SD card, click on the picture folder and choose the picture file you would like to view.

Playback Recorded Video: If video files are stored on the SD card, click on the video folder and choose the video file you would like to view.

Refresh: Reloads the file and folder information from the SD card.

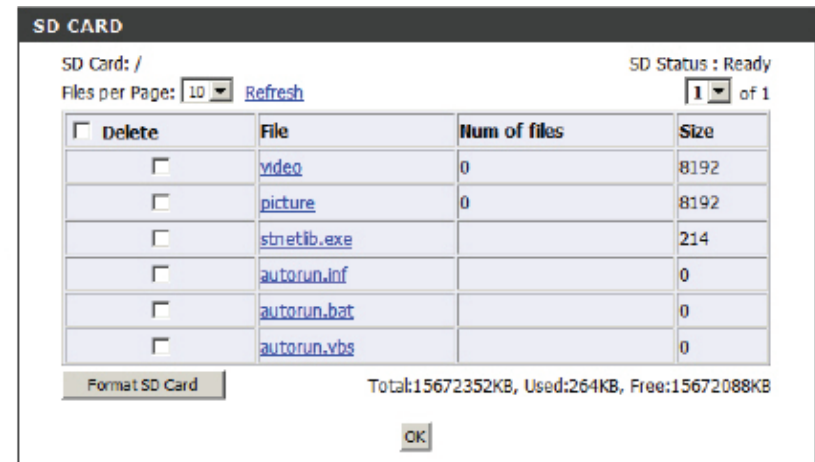
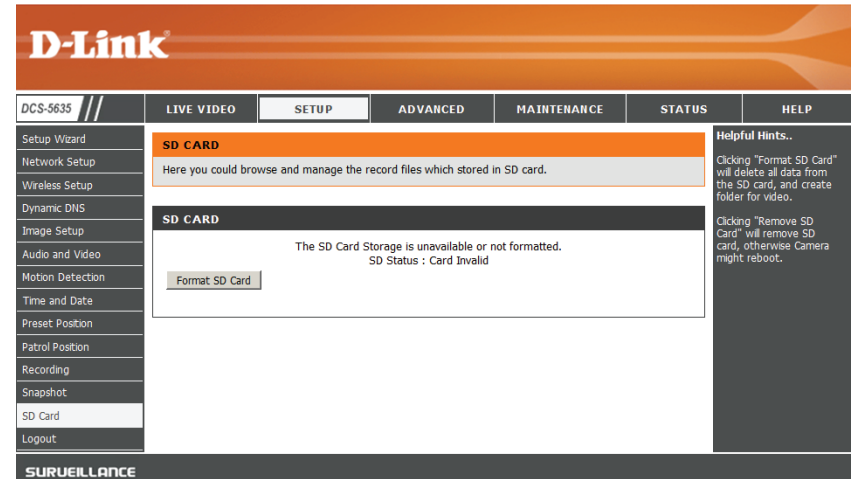

Advanced ICR

D-Link

DCS-5635 // LIVE VIDEO SETUP **ADVANCED** MAINTENANCE STATUS HELP

ICR

Digital Output

Logout

ICR

An IR (Infrared) Cut-Removable(ICR) filter can be disengaged from the image path for increased sensitivity in low light environments. The ICR filter will automatically engage depending on the ambient light, allowing the camera to be effective in day/night environments.

1. Select the Day/Night from the radio button. The available options are Automatic, Schedule mode, Day mode and Night mode.
2. The default value is Automatic.

Save Settings Don't Save Settings

ICR

IR-Cut Removable filter trigger condition:

- Automatic
- Day mode
- Night mode
- Scheduled mode

Day mode(24hr)

From [] [] to [] []

Helpful Hints..

ICR :

Automatic:The Day/Night mode is set automatically . It is normally set in the Day mode and changes to the Night mode in a dark place.

Day mode:The Day mode means disable the IR Cut Filter .

Night mode:The Night mode means enable the IR Cut Filter .

Schedule mode:Set the Day/Night mode using the schedule. Fill in the time so the Day/Night mode is normally set to Day mode and it enters the Day mode at the start time and returns to the Night mode at the end time.

SURVEILLANCE

ICR: Click to triggers traditional alarming devices that connect to the system, such as alarm lights and sirens.

Automatic: The camera will automatically enable or disable ICR depending on the amount of light is detected.

Day Mode: Select if your camera is in a high-light area.

Night Mode: Select if your camera is in a low-light area and you need to improve the video quality.

Schedule Mode: Select to set a specific time range to enable Day mode. The camera will switch to Night mode when outside this time range.

Digital Output

The I/O connector on the camera provides the physical interface for digital output (DO) and digital input (DI) that is used for connecting such external alarm devices as IR-Sensors and alarm relays to the PTZ IP camera.

External I/O Port

I/O Connector Definition for the Camera

The DCS-5605/DCS-5635 provides a general I/O terminal block with one digital input and one relay switch for device control. Pin 1 and pin 2 can be connected to an external sensor and the state of voltage will be monitored from the initial state 'LOW'. The relay switch of pin 3 and pin 4 can be used to turn on or off the external device.

The I/O connector provides the physical interface for digital output (DO) and digital input (DI) that is used for connecting a diversity of external alarm devices to the Camera such as IR-Sensors and alarm relays.

The digital input is used for connecting external alarm devices and once triggered images will be taken and e-mailed.



I/O Connector

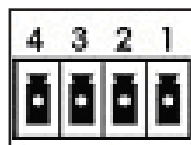

- 1 DI+
- 2 DI-
- 3 SW_COMMON
- 4 SW_NOPEN

- INPUT (Max. 50mA, 12VDC)
- INPUT (Initial state of DI is low)
- OUTPUT (open from SW_OPEN at initial state)
(close with SW_OPEN when set DO to ON)
- OUTPUT (Max. 1A, 24VDC or 0.5A, 125VAC)

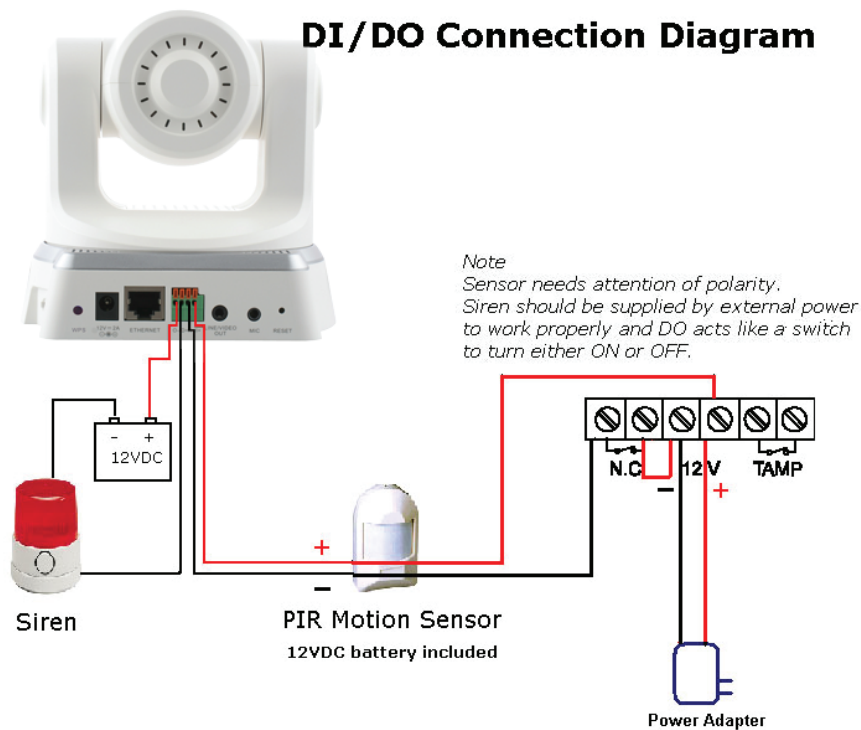

The above diagram shows a typical wiring configuration for a normally closed PIR motion sensor. Please refer to your specific motion sensor for the power supply connection to the device since this will be critical to the success of your installation. Note that the positive from the PIR is connected to the D+ of the I/O port of the camera and the negative from the PIR is connected to the D- of the camera I/O port.

External Trigger Configuration

Configuring Your Camera for External Trigger-Based Recording

To configure your camera to record when triggered by an external device, you must first set your SMTP or FTP settings in order to send snapshots to your email account or FTP server, or video to your Samba network drive or an inserted Micro SD memory card.

To record video to your Samba network drive or an inserted Micro SD memory card, go to the **Setup > Recording** section. If you want to record snapshots to your FTP server or sent to your email, skip to the next page.

Step 1 - Check the **Enable Recording** box.

Step 2 - Under *Record to*, select either **SD Card** or **Samba Network Drive**. If you select Samba, entered the required information.

Step 3 - Under *Recording Options*, select the following options:

- **Resolution** - Select the video profile from the drop-down menu.
- **Record until xxx MB of free space** - Enter the amount of free space on the selected drive before either stop recording or overwrite old recordings.

Step 4 - Under *Recording Method*, select **Event Based** and then select **Motion Detection Triggered Recording** and/or **Input 1 Triggered Recording**.

Step 5 - Enter the **Prerecord** and **Postrecord** time in seconds. For example, if you enter 4 seconds for both, the camera will record 4 seconds before the trigger and then 4 seconds after the event has ended.

Step 6 - Click **Save Settings**. Skip to page 65 to continue.

The screenshot shows the D-Link web interface for the DCS-5635 camera. The 'RECORDING' section is active, showing the following configuration options:

- Enable recording:** (unchecked)
- Record to:**
 - SD Card: SD Card status: Disable (Get Status)
 - Samba network drive: Samba Auth: Anonymous (dropdown), User name: [text box], Password: [text box], Password confirm: [text box], Server: [text box], Shared folder: [text box], Test: [button], Samba status: Disable (Get Status)
- Recording Options:**
 - Resolution: profile 1 (dropdown)
 - Record until: 100 MB of free space is left (minimum is 32MB)
 - When storage is full:
 - Stop recording
 - Overwrite older recordings
- Recording Method:**
 - Event Based
 - Motion detection triggered recording
 - Digital input 1 triggered recording
 - Prerecord: 0 seconds (range 0 to 15 seconds)
 - Postrecord: 0 seconds (range 0 to 15 seconds)
 - Continuous (Samba only)
 - Scheduled (Samba only):

	Hours	Minutes	Hours	Minutes
<input checked="" type="checkbox"/> Sun	Start	0 : 0	End	24 : 0
<input checked="" type="checkbox"/> Mon	Start	0 : 0	End	24 : 0
<input checked="" type="checkbox"/> Tue	Start	0 : 0	End	24 : 0
<input checked="" type="checkbox"/> Wed	Start	0 : 0	End	24 : 0
<input checked="" type="checkbox"/> Thu	Start	0 : 0	End	24 : 0
<input checked="" type="checkbox"/> Fri	Start	0 : 0	End	24 : 0
<input checked="" type="checkbox"/> Sat	Start	0 : 0	End	24 : 0

Buttons: Save Settings, Don't Save Settings

To save snapshots to your FTP server or sent to your email, go to the **Setup > Snapshot** section. If you want to record video to your Samba network drive or an inserted Micro SD memory card, refer to the previous page.

Step 1 - Check the **Enable Snapshot** box.

Step 2 - Under *Scheduling*, check **Event Based**. Select **Motion Detection** and/or **D/I Signal 1**.

Step 3 - Select **Continuous (FTP Only)** to record snapshots all the time or **Scheduled (FTP Only)** to record snapshots based on the specified time period.

Step 4 - Under *Send To*, select either **Email Address** or **FTP Server**. Refer to pages 58-59 for more information on the individual fields.

Step 5 - Click **Save Settings**.

D-Link

DCS-5605 // LIVE VIDEO SETUP ADVANCED MAINTENANCE STATUS HELP

SNAPSHOT

In order to enable your camera to take snapshots, you must select the checkbox of 'Enable Snapshot'. Then, you can determine the trigger event(s) and FTP and/or email notification(s). The resolution of snapshot can be configured as in the video profile 3 in [Audio And Video](#).

Save Settings Don't Save Settings

SNAPSHOT

Enable Snapshot

Scheduling

Event Based

- Motion Detection
- D/I Signal 1

Continuous (FTP only)

Scheduled (FTP only)

		Hours	Minutes	Hours	Minutes
<input checked="" type="checkbox"/> Sun	Start	00	: 00	End	24 : 00
<input checked="" type="checkbox"/> Mon	Start	00	: 00	End	24 : 00
<input checked="" type="checkbox"/> Tue	Start	00	: 00	End	24 : 00
<input checked="" type="checkbox"/> Wed	Start	00	: 00	End	24 : 00
<input checked="" type="checkbox"/> Thu	Start	00	: 00	End	24 : 00
<input checked="" type="checkbox"/> Fri	Start	00	: 00	End	24 : 00
<input checked="" type="checkbox"/> Sat	Start	00	: 00	End	24 : 00

Send to:

E-mail Address

User Name

Password

SMTP Mail Server

Sender E-mail Address

Recipient E-mail Address

Port (range 1 to 65535)

FTP Server

User Name

Password

Host Name

Path

Filename Prefix

Port (range 1 to 65535)

Interval Seconds (range 1 to 86400 seconds)

Passive Mode

Save Settings Don't Save Settings

SURVEILLANCE

Helpful Hints..

You can choose to receive notifications by FTP and/or E-mail. The Test buttons are provided to test if your input settings are valid and functional.

Click on **Advanced** and then click **Digital Output** on the left side.

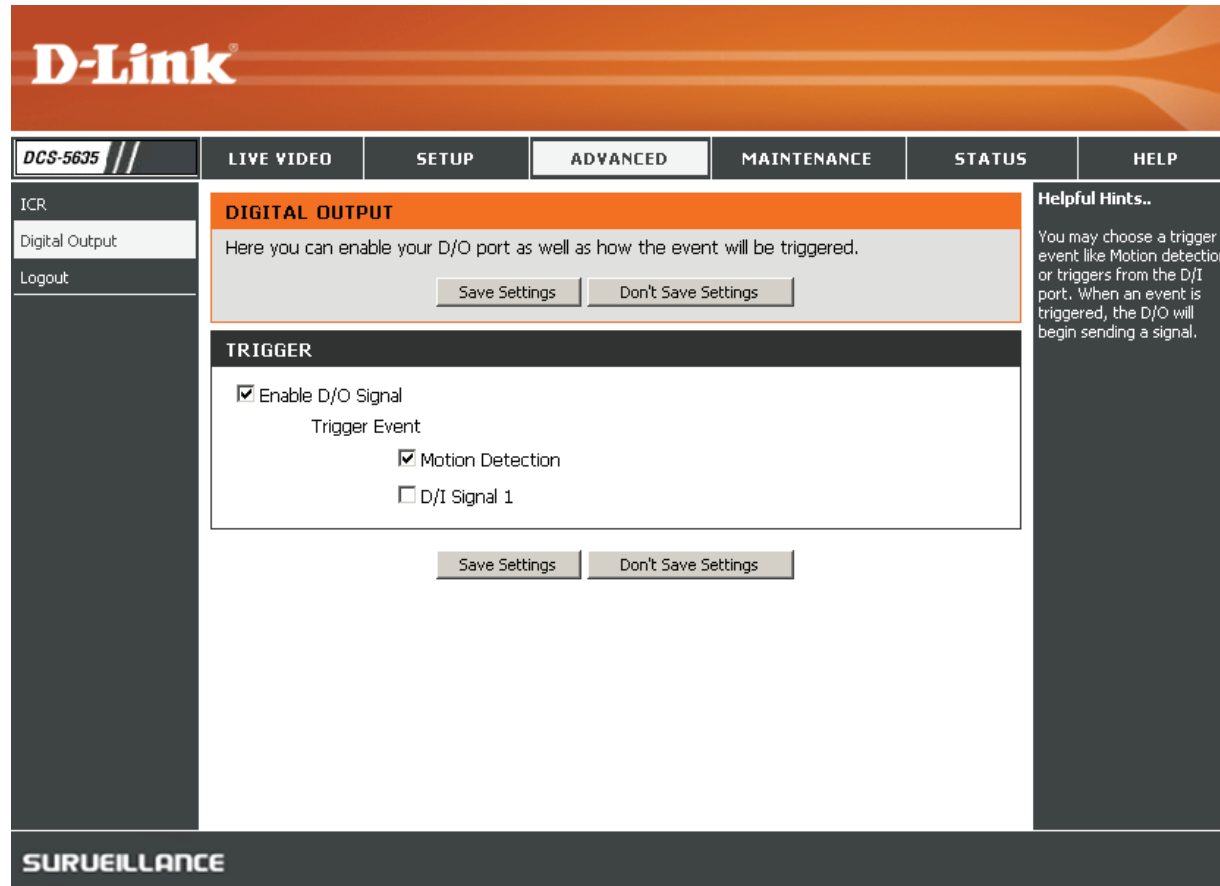

Enable D/O Signal: Click to triggers traditional alarming devices that connect to the system, such as alarm lights and sirens.

Motion Detection: When a motion is detected, the camera will trigger traditional alarming devices that connect to the system.

D/I Signal 1: When triggering the digital input 1 device, the camera will trigger traditional alarming devices that connect to the system.

Maintenance Admin

D-Link

DCS-5635 // LIVE VIDEO SETUP ADVANCED MAINTENANCE STATUS HELP

ADMIN

Here you can change the administrator's password for your account as well as add and/or delete user account(s). You can also configure a unique name for your camera, and enable its OSD (On-Screen Display) feature in order to display camera name and time stamp for both live video and recordings of your camera.

ADMIN PASSWORD SETTING

New Password 30 characters maximum
Retype Password Save

ADD USER ACCOUNT

User Name 20 users maximum
New Password 30 characters maximum
Retype Password
Add

USER LIST

User Name -- User list -- Delete

DEVICE SETTING

Camera Name DCS-5635 36 characters maximum
 Enable OSD
Label DCS-5635 30 characters maximum
Show time
LED light On Off
Save
Calibrate The Device

Helpful Hints..

For security purposes, it is recommended to change the password for your administrator account. Be sure to write down the new password to avoid having to reset the camera in the event that it is forgotten.

Enabling OSD, the camera name and time will be displayed on the video screen.

Recalibrate the home position to the default center to recover the tolerance caused by some external forces.

Admin Password: Change the password for the **admin** account.

User Account: Create user accounts. Enter a user name and then a password for that user. Click the **Add** button to add the user account.

User List: All accounts (except for the admin account) will be listed. To remove the user account, select from the drop-down menu and click the **Delete** button.

Device/PT Setting

DEVICE SETTING

Camera Name 36 characters maximum

Enable OSD

Label 30 characters maximum

Show time

LED light On Off

PT SETTING

Enable auto calibration

Calibrate The Device

Camera Name: Enter a name for the camera. This is useful when multiple cameras are on your network.

Enable OSD: Check to enable the on-screen display (OSD). This will display the label and the time on the video.

Label: Enter a name (I.E. a location such as “front door” or “parking lot”) to be displayed on the video.

Show Time: Check the box to display the date and time on the video (time stamp).

LED Light: Select **Off** to turn off the LED lights on the camera. This is useful to hide the camera or give the illusion the camera is turned off.

Calibrate the Device: Click the **Calibrate the Device** button to reset the home position to the default setting if the camera was moved by hand or an external force.

System

The screenshot displays the D-Link camera web interface. At the top, the D-Link logo is visible. Below it, a navigation bar contains tabs for LIVE VIDEO, SETUP, ADVANCED, MAINTENANCE, STATUS, and HELP. The MAINTENANCE tab is selected. On the left side, there is a sidebar with links for Admin, System, Firmware Upgrade, and Logout. The main content area is titled 'SYSTEM' and contains the following options:

- Save To Local Hard Drive: Save Configuration
- Load From Local Hard Drive: Browse... (with a text input field) and Load Configuration
- Restore To Factory Defaults: Restore Factory Defaults
- Reboot Device: Reboot Device

On the right side, there is a 'Helpful Hints..' section with the text: 'After the factory's default settings have been restored, use the installation wizard software provided with your camera to search and connect to the camera.'

At the bottom of the interface, the word 'SURVEILLANCE' is displayed.

Save to Local Hard Drive: Click the **Save Configuration** button to save the camera settings to a file.

Load From Local Hard Drive: To load a configuration file, click the **Browse** button and navigate to a configuration file. Click the file and click **OK** and then click the **Load Configuration** button to apply the settings to the camera.

Restore to Factory Defaults: Click the **Restore Factory Defaults** button to set the camera back to the factory default settings.

Reboot Device: Click the **Reboot Device** button to restart the camera.

Firmware Upgrade

Your current firmware version and date will be displayed on your screen. You may go to the D-Link Support page to check for the latest firmware version available.

The screenshot shows the D-Link web interface for a DCS-5635 camera. The top navigation bar includes 'LIVE VIDEO', 'SETUP', 'ADVANCED', 'MAINTENANCE', 'STATUS', and 'HELP'. The 'MAINTENANCE' tab is active. On the left sidebar, 'Firmware Upgrade' is selected. The main content area is titled 'FIRMWARE UPGRADE' and contains the following text:

FIRMWARE UPGRADE

A new firmware upgrade may be available for your IP camera. It is recommended to keep your IP camera firmware up-to-date to maintain and improve the functionality and performance of your internet camera. Click here [D-Link Support Page](#) to check for the latest firmware version available.

To upgrade the firmware on your IP camera, please download and save the latest firmware version from the D-Link Support Page to your local hard drive. Locate the file on your local hard drive by clicking the Browse button. Once you have found and opened the file using the browse button, click the "Upload" button to start the firmware upgrade.

FIRMWARE INFORMATION

Current Firmware Version: 1.00, 3709
Current Product Name: DCS-5635

FIRMWARE UPGRADE

File Path:

On the right side, there is a 'Helpful Hints..' section with the following text:

Helpful Hints..

Firmware upgrade are released periodically to improve the functionality of your IP camera and also to add new features. If you run into a problem with a specific feature of the IP camera, check our support site by clicking [here](#) to check for an upgrade and see if updated firmware is available for your IP camera.

The bottom of the page features a 'SURVEILLANCE' logo.

Firmware Upgrade: To upgrade the firmware on your camera, please download and save the latest firmware version from the D-Link Support page to your local hard drive. Locate the file on your local hard drive by clicking the **Browse** button. Then, open the file and click the **Upload** button to start the firmware upgrade. Do NOT power the camera off during this process.

Status

Device Info

This page displays all the details information about your device and network connection.

The screenshot shows the D-Link web interface for a DCS-5635 device. The top navigation bar includes links for LIVE VIDEO, SETUP, ADVANCED, MAINTENANCE, STATUS, and HELP. The main content area is titled 'DEVICE INFO' and contains a table of network and device information. A 'Helpful Hints..' section on the right explains that the page displays camera and network settings.

INFORMATION	
Camera Name	DCS-5635
Time & Date	Sat Dec 12 16:06:36 2009
Firmware Version	1.00, 3709
MAC Address	00:03:1B:58:92:13
IP Address	192.168.1.101
IP Subnet Mask	255.255.255.0
Default Gateway	192.168.1.1
Primary DNS	192.168.1.1
Secondary DNS	
PPPoE	Disable
DDNS	Disable

Log

This page displays the log information of your camera. You can save the log to a .txt file to your hard drive by clicking the **Download** button.

D-Link

DCS-5635 // LIVE VIDEO SETUP ADVANCED MAINTENANCE **STATUS** HELP

Device Info
Log
Logout

SYSTEM LOG
The system log records camera events that have occurred.

CURRENT LOG
2009-12-04 06:25:43 System is booted up.
2009-12-11 14:51:42 System is booted up.

Clear Download

Helpful Hints..
You can save the log to your local hard drive by clicking the Download button, and you can clear the log by clicking on the Clear button.

SURVEILLANCE

Help

The screenshot displays the D-Link web interface for the DCS-5635 camera. At the top, the D-Link logo is visible on an orange background. Below the logo is a navigation bar with tabs for LIVE VIDEO, SETUP, ADVANCED, MAINTENANCE, STATUS, and HELP. The HELP tab is currently selected. On the left side, there is a sidebar with 'Help Menu' and 'Logout' options. The main content area is titled 'HELP MENU' and is organized into sections: LIVE VIDEO (containing 'Camera'), SETUP (containing a list of configuration options like Setup Wizard, Network Setup, etc.), MAINTENANCE (containing Admin, System, and Firmware Upgrade), and STATUS (containing Device Info and Log). At the bottom of the page, the word 'SURVEILLANCE' is displayed.

DCS-5635 //	LIVE VIDEO	SETUP	ADVANCED	MAINTENANCE	STATUS	HELP
Help Menu	HELP MENU					
Logout	LIVE VIDEO SETUP MAINTENANCE STATUS					
	LIVE VIDEO					
	Camera					
	SETUP					
	Setup Wizard Network Setup Wireless Setup Dynamic DNS Image Setup Audio and Video Motion Detection Time and Date Preset Position Recording Snapshot Digital Output SD Card					
	MAINTENANCE					
	Admin System Firmware Upgrade					
	STATUS					
	Device Info Log					
SURVEILLANCE						

Appendix

Frequently Asked Questions

1. What is an Internet Camera?

The Internet Camera is a stand-alone system connecting directly to an Ethernet or Fast Ethernet network. It differs from a conventional PC Camera, the Internet Camera is an all-in-one system with built-in CPU and Web-based solutions providing a low cost solution that can transmit high quality video images for monitoring. The Internet Camera can be managed remotely, accessed and controlled from any PC/Notebook over an Intranet or the Internet from a Web browser.

2. What is the maximum number of users that can be allowed to access DCS-5605/5635 simultaneously?

The maximum number of users that can log onto the Internet Camera at the same time is 10. Please keep in mind the overall performance of the transmission speed will slow down when many users are logged on.

3. What algorithm is used to compress the digital image?

The Internet Camera utilizes MPEG-4 Simple Profile Mode image compression technology to provide high quality images.

4. Can I capture still images from the Internet Camera?

Yes you are able to capture still images with the snapshot function from the software application CD supplied with the Internet Camera or with the snapshot function on the Home page using an Internet browser.

5. Can the Internet Camera be used outdoors?

The Internet Camera is not weatherproof, and needs to be equipped with a weatherproof case in order to be used outdoors (recommended).

6. When physically connecting the Internet Camera to a network what network cabling is required?

The Internet Camera uses Category 5 UTP cable allowing 10 Base-T and 100 Base-T networking.

7. Can the Internet Camera be setup as a PC-cam on a computer?

No, the DCS-5635 Internet Camera is used only on a wireless 802.11n/g, Ethernet, or Fast Ethernet network.

8. Can the DCS-5605/5635 be connected to the network if it consists of only private IP addresses?

Yes, the Internet Camera can be connected to a LAN with private IP addresses.

9. Can the DCS-5605/5635 be installed and work if a firewall exists on the network?

If a firewall exists on the network, port 80 needs to be opened for ordinary data communication. The DCS-5605/5635 uses HTTP port and RTSP port to stream video data. These ports (or the ports you specify from the Advanced Tab in the Configuration screen if you change the default ports) need to be opened in the firewall device.

10. Why am I unable to access the DCS-5605/5635 from a Web browser?

If a router or firewall is used on the network, the correct ports for the DCS-5605/5635 may not be configured on the router or firewall. To correct the problem, you need to determine if the DCS-5605/5635 is behind a router or firewall and if the router or firewall is properly configured for the ports the DCS-5605/5635 is using.

Other possible problems might be due to the network cable. Try replacing your network cable. Test the network interface of the product by connecting a local computer to the unit, utilizing a Ethernet crossover cable. If the problem is not solved the Internet Camera might be faulty.

11. Why does the Internet Camera work locally but not externally?

This might be caused by network firewall protection. The firewall may need to have some settings changed in order for the Internet Camera to be accessible outside your local LAN. Check with the Network Administrator for your network.

Make sure that the Internet Camera is not conflicting with any Web server you may have running on your network. The default router setting might be a possible reason. Check that the configuration of the router settings allow the Internet Camera to be accessed outside your local LAN.

12. I connected the Internet Camera directly to a computer with a cross-over cable Ethernet cable and received the following Windows error upon running the Installation Wizard:

This Windows error will occur if the Internet Camera is connected to a computer that is not properly configured with a valid IP address. Turn off DHCP from the Network Settings in Windows® and configure the computer with a valid IP address, or connect the camera to a router with DHCP enabled.



13. Why does a series of broad vertical white lines appear throughout the image?

It could be that the CMOS sensor has become overloaded when it has been exposed to bright lights such as direct exposure to sunlight or halogen lights. Reposition the Internet Camera into a more shaded area immediately as prolonged exposure to bright lights will damage the CMOS sensor.

14. Noisy images occur. How can I solve the problem?

The video images might be noisy if the Internet Camera is used in a very low light environment. To solve this issue you need more lighting.

15. The images appear to be of poor quality, how can I improve the image quality?

Make sure that your computer's display properties are set above 256 colors. Using 16 or 256 colors on your computer will produce dithering artifacts in the image, making the image appear to be of poor quality.

The configuration on the Internet Camera image display is incorrect. Through the Image Setup section of the Web management you need to adjust the image related parameters such as brightness, contrast, hue and power line frequency for fluorescent light. Please refer to the Image Setup section for detailed information.

How to Ping Your IP Address

The PING (Packet Internet Groper) command can determine whether a specific IP address is accessible by sending a packet to the specific address and waiting for a reply. It can also provide a very useful tool to confirm if the IP address conflicts with Camera over the network.

Follow the step-by-step procedure below to utilize the PING command but first you must disconnect the Camera from the network.

Click on **Start > Run** and type in **CMD**

Type ping x.x.x.x, where x.x.x.x is the IP address of the Camera.

The replies, as illustrated below, will help diagnose any connection problems.

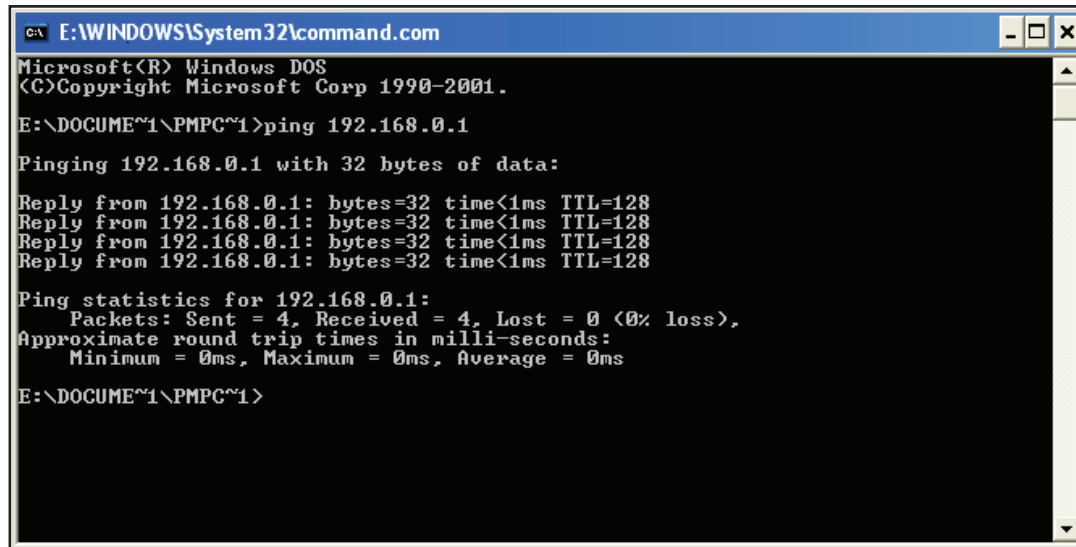

```
cmd E:\WINDOWS\System32\command.com
Microsoft(R) Windows DOS
(C)Copyright Microsoft Corp 1990-2001.

E:\DOCUME~1\PMPC~1>ping 192.168.0.1

Pinging 192.168.0.1 with 32 bytes of data:

Reply from 192.168.0.1: bytes=32 time<1ms TTL=128
Reply from 192.168.0.1: bytes=32 time<1ms TTL=128
Reply from 192.168.0.1: bytes=32 time<1ms TTL=128
Reply from 192.168.0.1: bytes=32 time<1ms TTL=128

Ping statistics for 192.168.0.1:
    Packets: Sent = 4, Received = 4, Lost = 0 (0% loss),
    Approximate round trip times in milli-seconds:
        Minimum = 0ms, Maximum = 0ms, Average = 0ms

E:\DOCUME~1\PMPC~1>
```

Using & Configuring 3G Compatible Cell Phones

To enable mobile device video streaming, you will need to configure profile 4 for mobile viewing (see below).

DCS-5635 //	LIVE VIDEO	SETUP	ADVANCED	MAINTENANCE	STATUS	HELP												
Setup Wizard	Audio And Video					<p>Helpful Hints..</p> <p>Encode Type - Select the video codec 'JPEG', 'MPEG4' or 'H264'.</p> <p>Resolution - 3 options depend on display system used.</p> <p>FPS (Frame per second) - 30fps is the highest video quality for this camera.</p> <p>bps (bit per second) - Select a fixed bandwidth for your camera operation. Higher value means a higher quality image but consumes more network bandwidth.</p> <p>JPEG Quality - Set the quality of JPEG image.</p> <p>RTSP URL - The URL used to connect to the camera when viewing from a mobile device or PDA. (i.e. rtsp://EXAMPLE.dlinkdns.com/3gpp).</p> <p>Audio Setup - To switch the external speaker and microphone on/off or adjust the volume.</p> <p>Enable Speaker - Enabling this feature to allow you to talk using PC's microphone and your voice to be transmitted to the external speaker connected to the camera.</p> <p>Speaker Volume - You can adjust the speaker volume using the volume level setting.</p>												
Network Setup	<p>This section allows you to configure the sound and video of your camera, you can configure different settings depending on whether you are viewing content from a PC or a Mobile phone/PDA.</p> <p style="text-align: center;"> <input type="button" value="Save Settings"/> <input type="button" value="Don't Save Settings"/> </p>																	
Wireless Setup	VIDEO PROFILE 1																	
Dynamic DNS	<table border="1"> <thead> <tr> <th>Encode Type</th> <th>Resolution</th> <th>FPS</th> <th>bps</th> <th>JPEG Quality</th> <th>RTSP URL</th> </tr> </thead> <tbody> <tr> <td>H264</td> <td>704x576</td> <td>25</td> <td>2 Mbps</td> <td>--</td> <td>play1.sdp</td> </tr> </tbody> </table>						Encode Type	Resolution	FPS	bps	JPEG Quality	RTSP URL	H264	704x576	25	2 Mbps	--	play1.sdp
Encode Type	Resolution	FPS	bps	JPEG Quality	RTSP URL													
H264	704x576	25	2 Mbps	--	play1.sdp													
Image Setup	VIDEO PROFILE 2																	
Audio and Video	<table border="1"> <thead> <tr> <th>Encode Type</th> <th>Resolution</th> <th>FPS</th> <th>bps</th> <th>JPEG Quality</th> <th>RTSP URL</th> </tr> </thead> <tbody> <tr> <td>H264</td> <td>704x576</td> <td>8</td> <td>768 Kbps</td> <td>Good</td> <td>play2.sdp</td> </tr> </tbody> </table>						Encode Type	Resolution	FPS	bps	JPEG Quality	RTSP URL	H264	704x576	8	768 Kbps	Good	play2.sdp
Encode Type	Resolution	FPS	bps	JPEG Quality	RTSP URL													
H264	704x576	8	768 Kbps	Good	play2.sdp													
Motion Detection	VIDEO PROFILE 3																	
Time and Date	<table border="1"> <thead> <tr> <th>Encode Type</th> <th>Resolution</th> <th>FPS</th> <th>bps</th> <th>JPEG Quality</th> <th>RTSP URL</th> </tr> </thead> <tbody> <tr> <td>JPEG</td> <td>704x576</td> <td>8</td> <td>--</td> <td>Good</td> <td>play3.sdp</td> </tr> </tbody> </table>					Encode Type	Resolution	FPS	bps	JPEG Quality	RTSP URL	JPEG	704x576	8	--	Good	play3.sdp	
Encode Type	Resolution	FPS	bps	JPEG Quality	RTSP URL													
JPEG	704x576	8	--	Good	play3.sdp													
Preset Position	VIDEO PROFILE 4 FOR MOBILE DEVICE ONLY																	
Patrol Position	<table border="1"> <thead> <tr> <th>Encode Type</th> <th>Resolution</th> <th>FPS</th> <th>bps</th> <th>JPEG Quality</th> <th>RTSP URL</th> </tr> </thead> <tbody> <tr> <td>MPEG4</td> <td>176x144</td> <td>5</td> <td>64 Kbps</td> <td>--</td> <td>3gpp</td> </tr> </tbody> </table>					Encode Type	Resolution	FPS	bps	JPEG Quality	RTSP URL	MPEG4	176x144	5	64 Kbps	--	3gpp	
Encode Type	Resolution	FPS	bps	JPEG Quality	RTSP URL													
MPEG4	176x144	5	64 Kbps	--	3gpp													
Recording	AUDIO SETUP																	
Snapshot	<table border="1"> <tbody> <tr> <td>Enable Speaker</td> <td><input checked="" type="checkbox"/></td> </tr> <tr> <td>Volume</td> <td>100</td> </tr> <tr> <td>Enable Microphone</td> <td><input checked="" type="checkbox"/></td> </tr> <tr> <td>Volume</td> <td>100</td> </tr> </tbody> </table> <p style="text-align: center;"> <input type="button" value="Save Settings"/> <input type="button" value="Don't Save Settings"/> </p>					Enable Speaker	<input checked="" type="checkbox"/>	Volume	100	Enable Microphone	<input checked="" type="checkbox"/>	Volume	100					
Enable Speaker	<input checked="" type="checkbox"/>																	
Volume	100																	
Enable Microphone	<input checked="" type="checkbox"/>																	
Volume	100																	
SD Card																		
Logout																		

Play from RealPlayer

The following steps are based on a Nokia 6630 cell phone.

Step 1 - Press the **Menu** button and select **Media**.

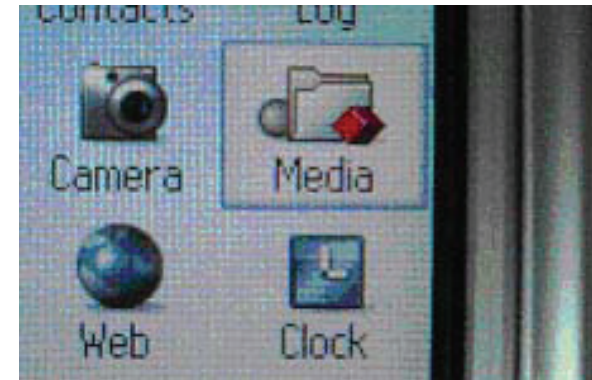

Step 2 - Select **Open**.

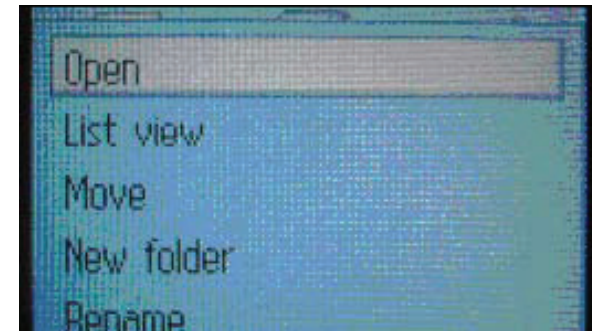

Step 3 - Select **RealPlayer**.

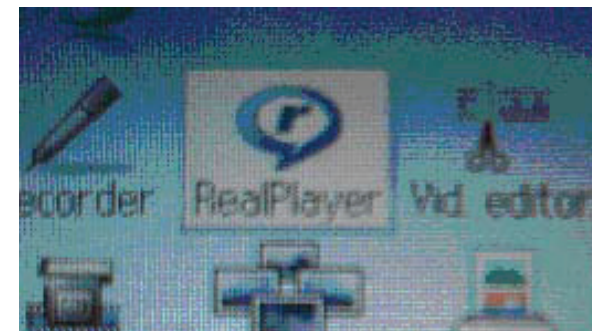

Step 4 - Select Open.

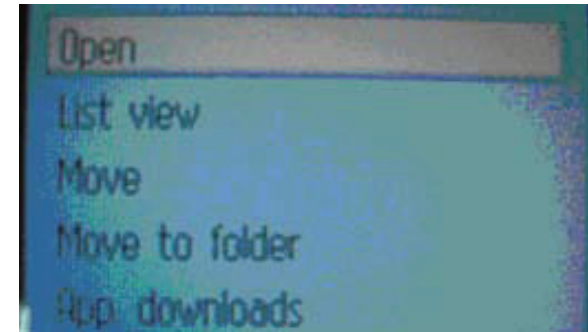

Step 5 - When RealPlayer opens, press Options.

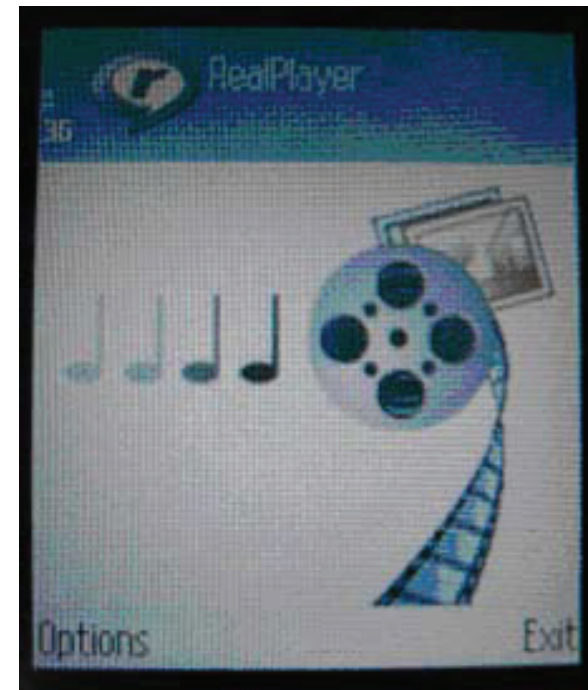

Step 6 - Select Download.

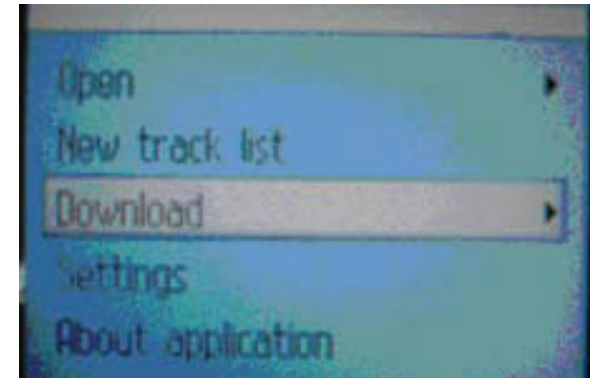

Step 7 - Select Video Clips. Note: 71.34.50.5 is the camera's IP address in this sample.

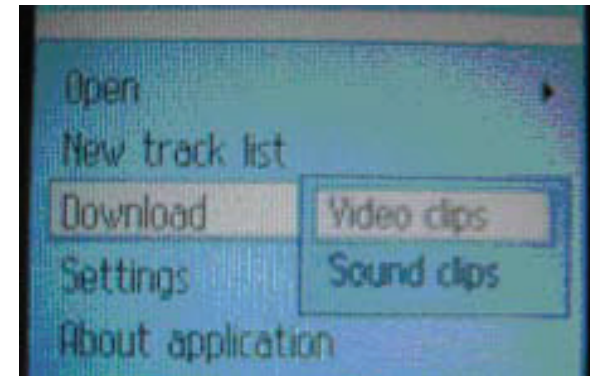

Step 8 - Press Options.

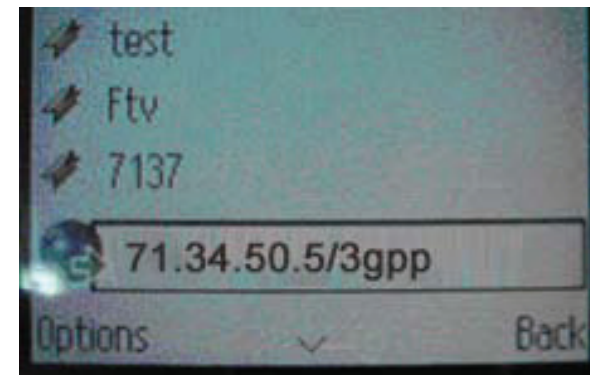

Step 9 - Select Navigation Options.

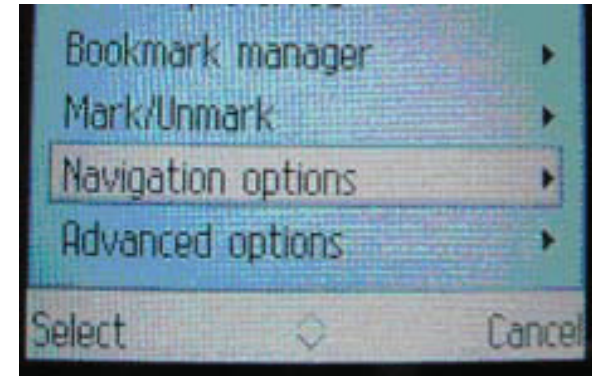

Step 10 - Select Go to web address.

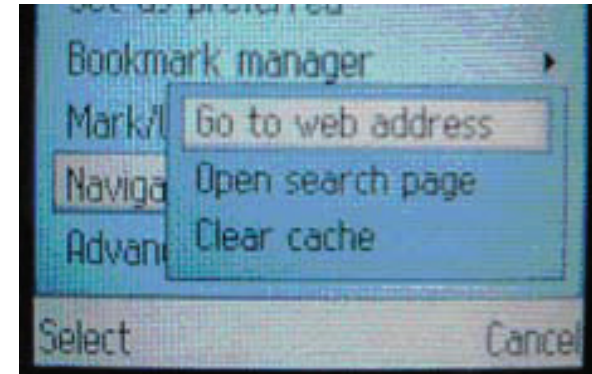

Step 11 - Input your rtsp address.

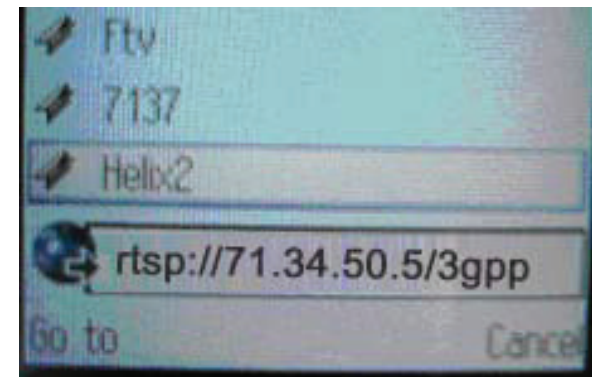

Step 12 - Press **Yes**, and allow Connection and Loading of the streaming video.

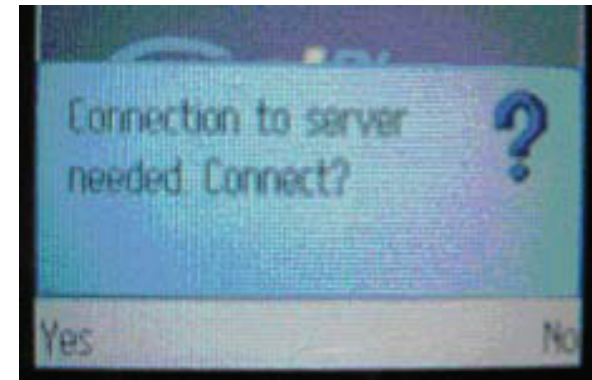

Step 13 - Enjoy streaming video on your cellphone.

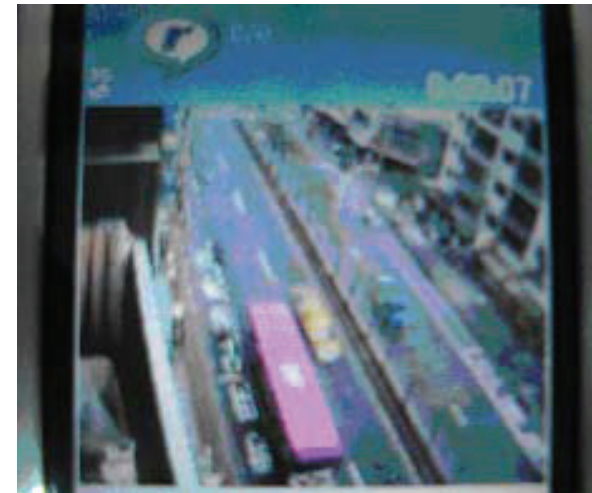

Play from PVPlayer

The following steps are based on a Nokia 6630 cell phone.

Step 1 - Press the **Menu** button and select **PVPlayer**.

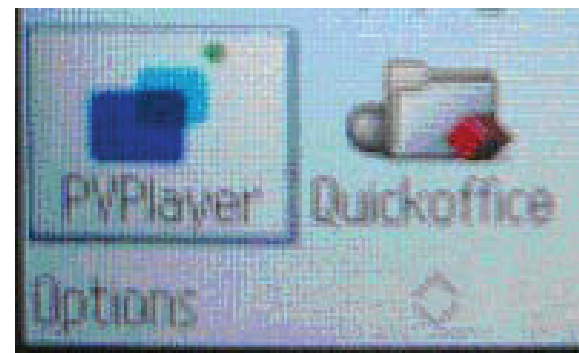

Step 2 - Select **Open**.

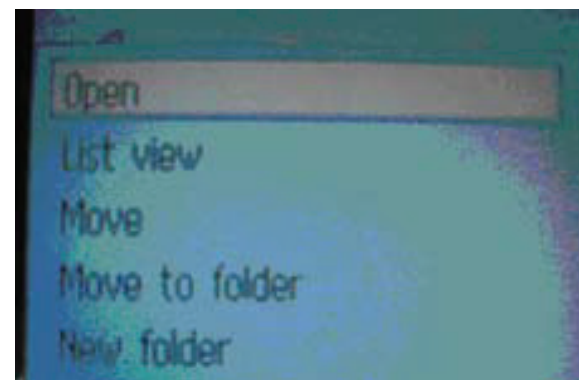

Step 3 - Press the **Options** button.

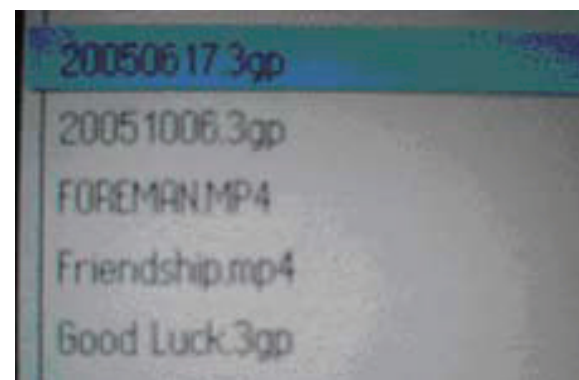

Step 4 - Select Open.

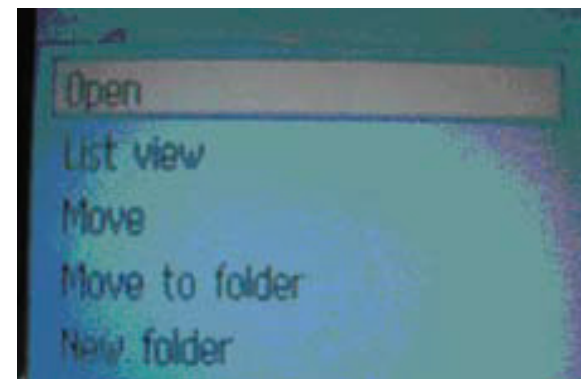

Step 5 - Input your rtsp address.

Note: 71.34.50.5 is the camera's IP address in this sample.

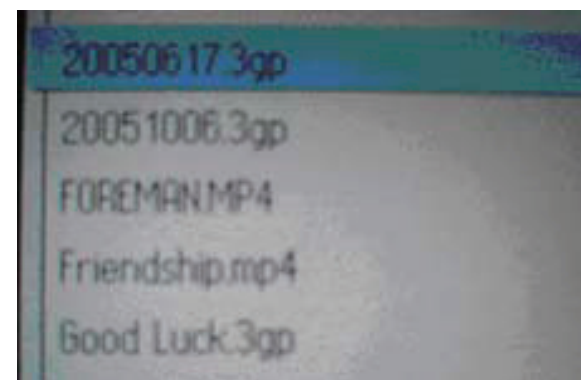

Step 6 - Enjoy streaming video on your cellphone.

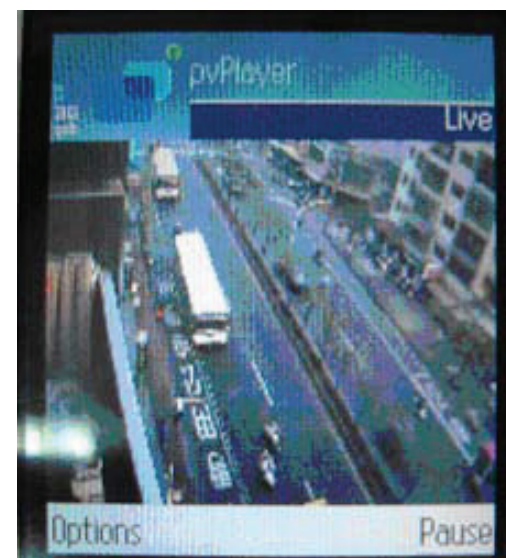

Reset and Restore

There is a button hidden in the pinhole beside the Ethernet socket. It is used to **reset** the system or **restore** the factory default settings. Sometimes resetting the DCS-5605/DCS-5635 will return the system back to a normal state. If the system still has problems after reset, restore the factory settings and install again:

RESET:

1. Lightly insert a paper clip (or a similar sized tool) into the reset hole on the back of the camera, press lightly and then release the button.
2. The LED on the front of the camera will begin blinking red and green.
3. When the LED stops the blinking the reset has completed.

RESTORE:

1. Insert the paperclip or other tool and press on the button continuously.
2. Wait for the LED on the front of the camera to blink red and green and hold the button through two cycles of blinking (about 5-7 seconds.)
3. Withdraw the tool after the second cycle of the LED blinking and a factory restore has been completed.

Restoring the factory defaults will result in the loss of any previous settings and will require running the Installation Wizard to return the DCS-5605/DCS-5635 to a normal state.

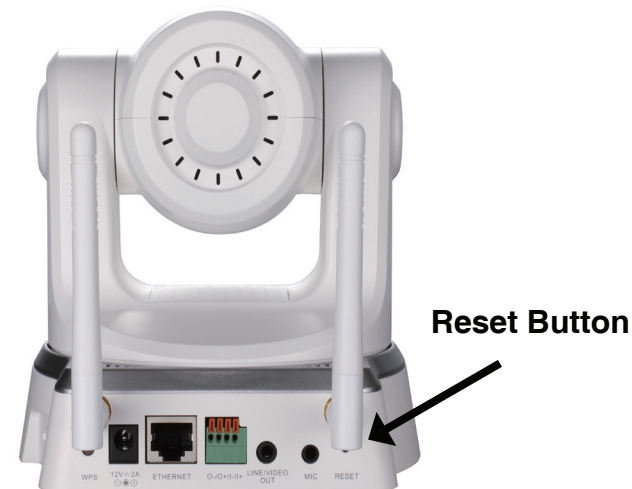

Enabling UPnP™ for Windows® XP

UPnP™ is short for Universal Plug and Play, which is a networking architecture that provides compatibility among networking equipment, software, and peripherals. The DCS-5605/DCS-5635 is a UPnP™ enabled Camera. If your operating system is UPnP™ enabled, the device will be easier to configure. If you do not want to use the UPnP™ functionality, it can be disabled by unselecting **“Enabled”** on the DDNS/UPnP™ settings page under **Advanced** in the configuration menu. Use the following steps to enable UPnP™ (Universal Plug and Play) settings only if you are running Windows® XP.

Step 1 - Go to Start > Settings > Control Panel.

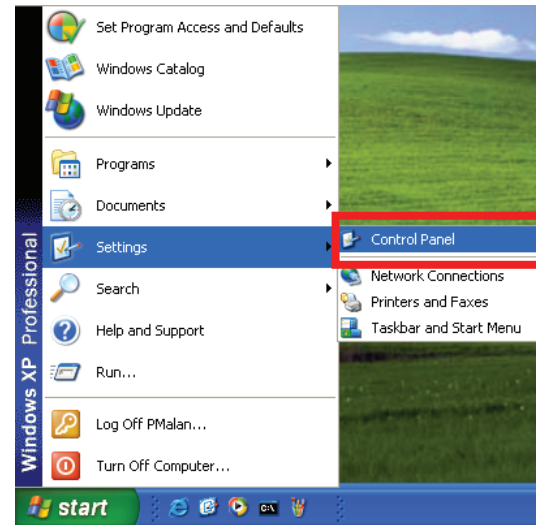

Step 2 - Click Add or Remove Programs

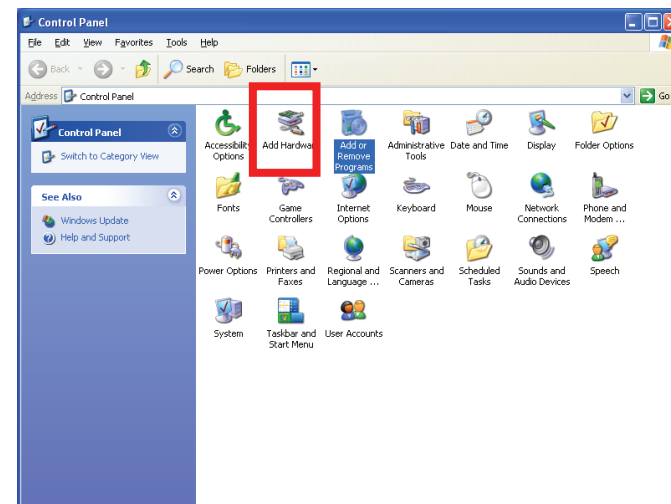

Step 3 - Click Add/Remove Windows Components.

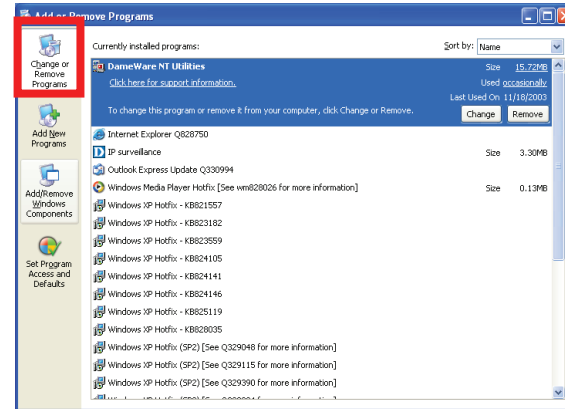

Step 4 - The following screen will appear. Click Add/Remove Windows Components, highlight Networking Services, and then click Details.

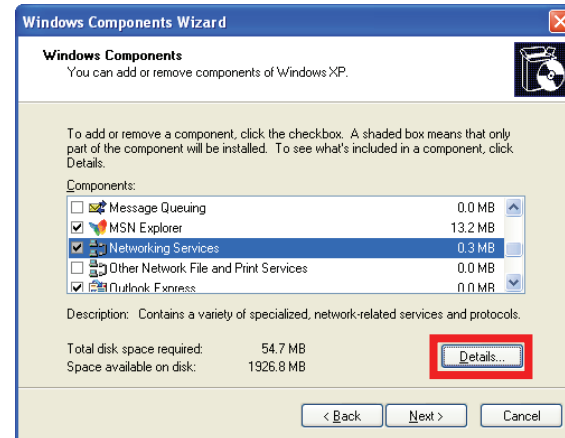

Step 5 - Check the Universal Plug and Play box and then click OK.

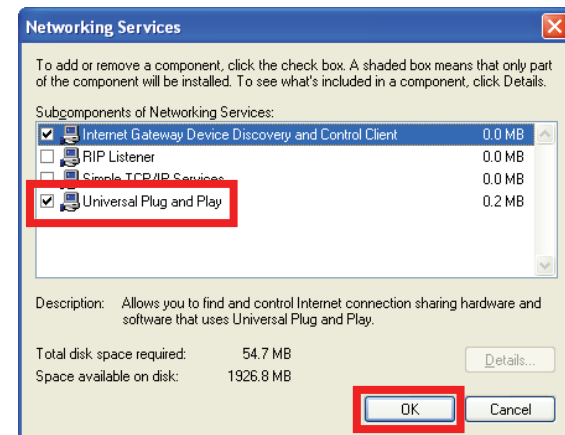

Step 6 - Click Next to continue.

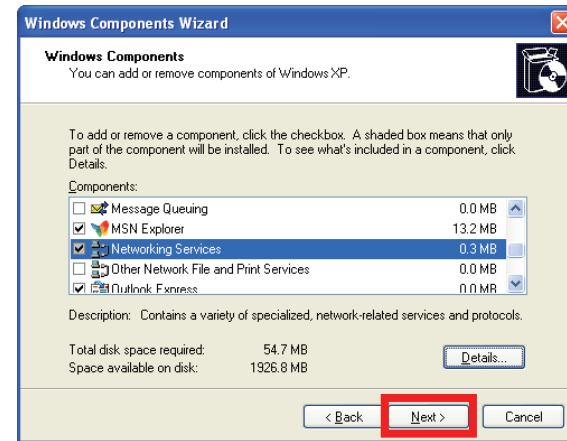

Step 7 - Please wait while Setup configures the components.

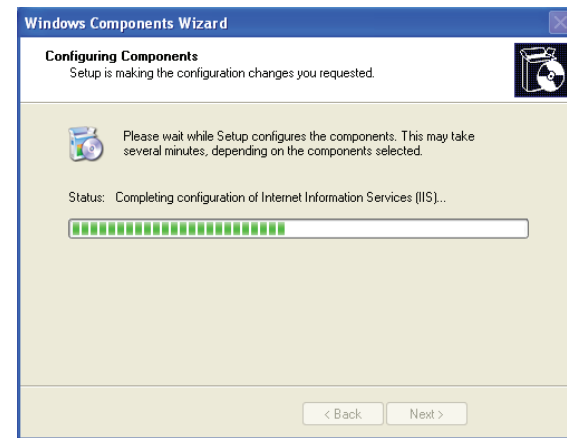

Step 8 - Click Finish.



Step 9 - To view your DCS-5605/DCS-5635 Camera in an Internet browser, go to your Desktop and click **My Network Places**.



Step 10 - The last three digits (146), represent the fourth octet of your Camera's IP address (in this example, 198.168.0.146).

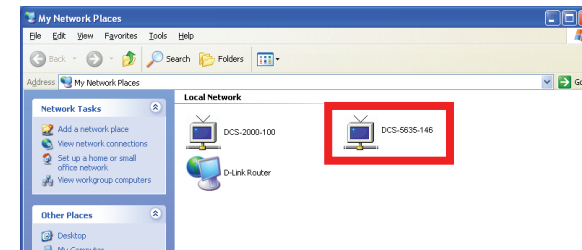

Step 11 - After you click on the **DCS-5605/DCS-5635-146** icon, your Internet browser will automatically be opened to the IP address of the camera, in this example it is: <http://192.168.0.146>. Your camera may have a different IP Address.

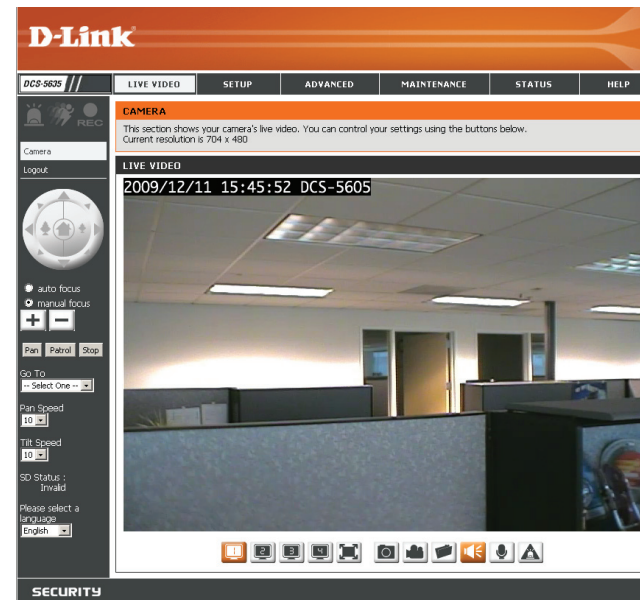

Technical Specifications

PACKAGE CONTENTS

- Internet Camera
- 12V/2A External Power Adapter
- CAT5 Ethernet cable
- Quick Install Guide
- Master CD
- A/V Cable
- Plate
- Mounting Screws
- 2 Wireless Antennas (DCS-5635 only)

CAMERA SPECIFICATIONS

- Minimum Illumination:
 - Color: 0.7 Lux / F1.8
 - B/W: 0.02 Lux / F1.8
- Pan angle: +/- 165 degrees
- Tilt angle: -87 to +34 degrees
- Field of View (approximate)
 - Horizontal: 51° (Wide) to 6° (Tele)
 - Vertical: 40° (Wide) to 4° (Tele)
 - Diagonal: 63° (Wide) to 7° (Tele)

NETWORK CONNECTIVITY

- 10/100 Mbps Fast Ethernet Auto-Negotiation
- Power over Ethernet

PROTOCOLS

- IPv4, ARP, TCP, UDP, ICMP, DHCP Client, NTP Client (D-Link), DNS Client, DDNS Client (D-Link), SMTP Client, FTP Client, HTTP Server, Samba Client, PPPoE, UpnP Port Forwarding, RTP, RTSP, RTCP, 3GPP

LEDS

- Link/Power/WPS

WIRELESS*

- Security: WEP, WPA-PSK, WPA2
- Supports WPS

RESOLUTION

- NTSC: 704 x 480 / 352x240 /176x120 : 30 fps
- PAL: 704 x 576 / 352x288 /176x144 : 25 fps

CODEC SUPPORT

- MPEG4/MJPEG/H.264 (simultaneous)
- JPEG for still image

INTERFACES

- LAN
- Microphone
- I/O
- Line/Video Out
- MicroSD
- WPS
- Reset

DATA RATES*

- IEEE 802.11n: From MCS0 to MCS15
- IEEE 802.11g: 54, 48, 36, 24, 18, 12, 9, 6 Mbps
- IEEE 802.11b: 11, 5.5,2, 1 Mbps
- Auto-select or Manual specified

POWER

- 12VDC/2A

POWER CONSUMPTION

- 100-240VAC, 50/60Hz, 0.4A

SYSTEM REQUIREMENTS

- Operating System: Windows® 7, Vista®, or XP
- Browser: Internet Explorer, Safari, Firefox, Mozilla or Opera

DIMENSIONS (L x W x H)

- 140.3 x 136.1 x 140.1 mm

WEIGHT

- DCS-5605: 810g
- DCS-5635: 855g

OPERATING TEMPERATURE

- 0° to 40° (32° to 104°)

STORAGE TEMPERATURE

- -20° to 70° (-4° to 158°)

OPERATING HUMIDITY

- 20%-80% RH non-condensing

CERTIFICATIONS

- FCC
- IC
- CE
- C-Tick

Contacting Technical Support

U.S. and Canadian customers can contact D-Link technical support through our web site or by phone.

Before you contact technical support, please have the following ready:

- Model number of the product (e.g. DCS-5605/DCS-5635)
- Hardware Revision (located on the label on the bottom of the Camera (e.g. rev A1))
- Serial Number (s/n number located on the label on the bottom of the Camera).

You can find software updates and user documentation on the D-Link website as well as frequently asked questions and answers to technical issues.

For customers within the United States:

Phone Support:

(877) 354-6555

Internet Support:

<http://support.dlink.com>

For customers within Canada:

Phone Support:

(877) 354-6560

Internet Support:

<http://support.dlink.ca>

Warranty

Subject to the terms and conditions set forth herein, D-Link Systems, Inc. (“D-Link”) provides this Limited Warranty:

- Only to the person or entity that originally purchased the product from D-Link or its authorized reseller or distributor, and
- Only for products purchased and delivered within the fifty states of the United States, the District of Columbia, U.S. Possessions or Protectorates, U.S. Military Installations, or addresses with an APO or FPO.

Limited Warranty: D-Link warrants that the hardware portion of the D-Link product described below (“Hardware”) will be free from material defects in workmanship and materials under normal use from the date of original retail purchase of the product, for the period set forth below (“Warranty Period”), except as otherwise stated herein.

- Hardware (excluding power supplies and fans): One (1) year
- Power supplies and fans: One (1) year
- Spare parts and spare kits: Ninety (90) days

The customer’s sole and exclusive remedy and the entire liability of D-Link and its suppliers under this Limited Warranty will be, at D-Link’s option, to repair or replace the defective Hardware during the Warranty Period at no charge to the original owner or to refund the actual purchase price paid. Any repair or replacement will be rendered by D-Link at an Authorized D-Link Service Office. The replacement hardware need not be new or have an identical make, model or part. D-Link may, at its option, replace the defective Hardware or any part thereof with any reconditioned product that D-Link reasonably determines is substantially equivalent (or superior) in all material respects to the defective Hardware. Repaired or replacement hardware will be warranted for the remainder of the original Warranty Period or ninety (90) days, whichever is longer, and is subject to the same limitations and exclusions. If a material defect is incapable of correction, or if D-Link determines that it is not practical to repair or replace the defective Hardware, the actual price paid by the original purchaser for the defective Hardware will be refunded by D-Link upon return to D-Link of the defective Hardware. All Hardware or part thereof that is replaced by D-Link, or for which the purchase price is refunded, shall become the property of D-Link upon replacement or refund.

Limited Software Warranty: D-Link warrants that the software portion of the product (“Software”) will substantially conform to D-Link’s then current functional specifications for the Software, as set forth in the applicable documentation, from the date of original retail purchase of the Software for a period of ninety (90) days (“Software Warranty Period”), provided that the Software is properly installed on approved hardware and operated as contemplated in its documentation. D-Link further warrants that, during the Software Warranty Period, the magnetic media on which D-Link delivers the Software will be free of physical defects. The customer’s sole and exclusive remedy and the entire liability of D-Link and its suppliers under this Limited Warranty will be, at D-Link’s option, to replace the non-conforming Software (or defective media) with software that substantially conforms to D-Link’s functional specifications for the Software or to refund the portion of the actual purchase price paid that is attributable to the Software. Except as otherwise agreed by D-Link in writing, the replacement Software is provided only to the original licensee, and is subject to the terms and conditions of the license granted by D-Link for the Software. Replacement Software will be warranted for the remainder of the original Warranty Period and is subject to the same limitations and exclusions. If a material non-conformance is incapable of correction, or if D-Link determines in its sole discretion that it is not practical to replace the non-conforming Software, the price paid by the original licensee for the non-conforming Software will be refunded by D-Link; provided that the non-conforming Software (and all copies thereof) is first returned to D-Link. The license granted respecting any Software for which a refund is given automatically terminates.

Non-Applicability of Warranty: The Limited Warranty provided hereunder for Hardware and Software portions of D-Link’s products will not be applied to and does not cover any refurbished product and any product purchased through the inventory clearance or liquidation sale or other sales in which D-Link, the sellers, or the liquidators expressly disclaim their warranty obligation pertaining to the product and in that case, the product is being sold “As-Is” without any warranty whatsoever including, without limitation, the Limited Warranty as described herein, notwithstanding anything stated herein to the contrary.

Submitting A Claim: The customer shall return the product to the original purchase point based on its return policy. In case the return policy period has expired and the product is within warranty, the customer shall submit a claim to D-Link as outlined below:

-
- The customer must submit with the product as part of the claim a written description of the Hardware defect or Software nonconformance in sufficient detail to allow D-Link to confirm the same, along with proof of purchase of the product (such as a copy of the dated purchase invoice for the product) if the product is not registered.
 - The customer must obtain a Case ID Number from D-Link Technical Support at 1-877-453-5465, who will attempt to assist the customer in resolving any suspected defects with the product. If the product is considered defective, the customer must obtain a Return Material Authorization (“RMA”) number by completing the RMA form and entering the assigned Case ID Number at <https://rma.dlink.com/>.
 - After an RMA number is issued, the defective product must be packaged securely in the original or other suitable shipping package to ensure that it will not be damaged in transit, and the RMA number must be prominently marked on the outside of the package. Do not include any manuals or accessories in the shipping package. D-Link will only replace the defective portion of the product and will not ship back any accessories.
 - The customer is responsible for all in-bound shipping charges to D-Link. No Cash on Delivery (“COD”) is allowed. Products sent COD will either be rejected by D-Link or become the property of D-Link. Products shall be fully insured by the customer and shipped to **D-Link Systems, Inc., 17595 Mt. Herrmann, Fountain Valley, CA 92708**. D-Link will not be held responsible for any packages that are lost in transit to D-Link. The repaired or replaced packages will be shipped to the customer via UPS Ground or any common carrier selected by D-Link. Return shipping charges shall be prepaid by D-Link if you use an address in the United States, otherwise we will ship the product to you freight collect. Expedited shipping is available upon request and provided shipping charges are prepaid by the customer.

D-Link may reject or return any product that is not packaged and shipped in strict compliance with the foregoing requirements, or for which an RMA number is not visible from the outside of the package. The product owner agrees to pay D-Link’s reasonable handling and return shipping charges for any product that is not packaged and shipped in accordance with the foregoing requirements, or that is determined by D-Link not to be defective or non-conforming.

What Is Not Covered: The Limited Warranty provided herein by D-Link does not cover: Products that, in D-Link’s judgment, have been subjected to abuse, accident, alteration, modification, tampering, negligence, misuse, faulty installation, lack of reasonable care, repair or service in any way that is not contemplated in the documentation for the product, or if the model or serial number has been altered, tampered with, defaced or removed; Initial installation, installation and removal of the product for repair, and shipping costs; Operational adjustments covered in the operating manual for the product, and normal maintenance; Damage that occurs in shipment, due to act of God, failures due to power surge, and cosmetic damage; Any hardware, software, firmware or other products or services provided by anyone other than D-Link; and Products that have been purchased from inventory clearance or liquidation sales or other sales in which D-Link, the sellers, or the liquidators expressly disclaim their warranty obligation pertaining to the product. While necessary maintenance or repairs on your Product can be performed by any company, we recommend that you use only an Authorized D-Link Service Office. Improper or incorrectly performed maintenance or repair voids this Limited Warranty.

Disclaimer of Other Warranties: EXCEPT FOR THE LIMITED WARRANTY SPECIFIED HEREIN, THE PRODUCT IS PROVIDED “AS-IS” WITHOUT ANY WARRANTY OF ANY KIND WHATSOEVER INCLUDING, WITHOUT LIMITATION, ANY WARRANTY OF MERCHANTABILITY, FITNESS FOR A PARTICULAR PURPOSE AND NON-INFRINGEMENT. IF ANY IMPLIED WARRANTY CANNOT BE DISCLAIMED IN ANY TERRITORY WHERE A PRODUCT IS SOLD, THE DURATION OF SUCH IMPLIED WARRANTY SHALL BE LIMITED TO THE DURATION OF THE APPLICABLE WARRANTY PERIOD SET FORTH ABOVE. EXCEPT AS EXPRESSLY COVERED UNDER THE LIMITED WARRANTY PROVIDED HEREIN, THE ENTIRE RISK AS TO THE QUALITY, SELECTION AND PERFORMANCE OF THE PRODUCT IS WITH THE PURCHASER OF THE PRODUCT.

Limitation of Liability: TO THE MAXIMUM EXTENT PERMITTED BY LAW, D-LINK IS NOT LIABLE UNDER ANY CONTRACT, NEGLIGENCE, STRICT LIABILITY OR OTHER LEGAL OR EQUITABLE THEORY FOR ANY LOSS OF USE OF THE PRODUCT, INCONVENIENCE OR DAMAGES OF ANY CHARACTER, WHETHER DIRECT, SPECIAL, INCIDENTAL OR CONSEQUENTIAL (INCLUDING, BUT NOT LIMITED TO, DAMAGES FOR LOSS OF GOODWILL, LOSS OF REVENUE OR PROFIT, WORK STOPPAGE, COMPUTER FAILURE OR MALFUNCTION, FAILURE OF OTHER EQUIPMENT OR COMPUTER PROGRAMS TO WHICH D-LINK’S PRODUCT IS CONNECTED WITH, LOSS OF INFORMATION OR DATA CONTAINED IN, STORED ON,

OR INTEGRATED WITH ANY PRODUCT RETURNED TO D-LINK FOR WARRANTY SERVICE) RESULTING FROM THE USE OF THE PRODUCT, RELATING TO WARRANTY SERVICE, OR ARISING OUT OF ANY BREACH OF THIS LIMITED WARRANTY, EVEN IF D-LINK HAS BEEN ADVISED OF THE POSSIBILITY OF SUCH DAMAGES. THE SOLE REMEDY FOR A BREACH OF THE FOREGOING LIMITED WARRANTY IS REPAIR, REPLACEMENT OR REFUND OF THE DEFECTIVE OR NON-CONFORMING PRODUCT. THE MAXIMUM LIABILITY OF D-LINK UNDER THIS WARRANTY IS LIMITED TO THE PURCHASE PRICE OF THE PRODUCT COVERED BY THE WARRANTY. THE FOREGOING EXPRESS WRITTEN WARRANTIES AND REMEDIES ARE EXCLUSIVE AND ARE IN LIEU OF ANY OTHER WARRANTIES OR REMEDIES, EXPRESS, IMPLIED OR STATUTORY.

Governing Law: This Limited Warranty shall be governed by the laws of the State of California. Some states do not allow exclusion or limitation of incidental or consequential damages, or limitations on how long an implied warranty lasts, so the foregoing limitations and exclusions may not apply. This Limited Warranty provides specific legal rights and you may also have other rights which vary from state to state.

Trademarks: D-Link is a registered trademark of D-Link Systems, Inc. Other trademarks or registered trademarks are the property of their respective owners.

Copyright Statement: No part of this publication or documentation accompanying this product may be reproduced in any form or by any means or used to make any derivative such as translation, transformation, or adaptation without permission from D-Link Corporation/D-Link Systems, Inc., as stipulated by the United States Copyright Act of 1976 and any amendments thereto. Contents are subject to change without prior notice.

Copyright © 2010 by D-Link Corporation/D-Link Systems, Inc. All rights reserved.

CE Mark Warning: This is a Class B product. In a domestic environment, this product may cause radio interference, in which case the user may be required to take adequate measures.

FCC Statement: This equipment has been tested and found to comply with the limits for a Class B digital device, pursuant to part 15 of the FCC Rules. These limits are designed to provide reasonable protection against harmful interference in a residential installation. This equipment generates, uses, and can radiate radio frequency energy and, if not installed and used in accordance with the instructions, may cause harmful interference to radio communication. However, there is no guarantee that interference will not occur in a particular installation. If this equipment does cause harmful interference to radio or television reception, which can be determined by turning the equipment off and on, the user is encouraged to try to correct the interference by one or more of the following measures:

- Reorient or relocate the receiving antenna.
- Increase the separation between the equipment and receiver.
- Connect the equipment into an outlet on a circuit different from that to which the receiver is connected.
- Consult the dealer or an experienced radio/TV technician for help.

For detailed warranty information applicable to products purchased outside the United States, please contact the corresponding local D-Link office.

Registration

Register your product online at:
<http://support.dlink.com/register>



Product registration is entirely voluntary and failure to complete or return this form will not diminish your warranty rights.

Version 1.1
November 26, 2010