



User Manual

5 Megapixel Day & Night Outdoor Network Camera

DCS-7517

Preface

D-Link reserves the right to revise this publication and to make changes in the content hereof without obligation to notify any person or organization of such revisions or changes.

Manual Revisions

Revision	Date	Description
1.00	06/29/2015	DCS-7517 Revision A1 with firmware version 1.00
1.10	10/16/2015	Minor updates
1.20	12/24/2015	Minor updates
1.30	07/04/2016	Updated Regulatory Information
1.40	03/31/2017	Minor updates

Trademarks

D-Link and the D-Link logo are trademarks or registered trademarks of D-Link Corporation or its subsidiaries in the United States or other countries. All other company or product names mentioned herein are trademarks or registered trademarks of their respective companies.

Copyright © 2017 by D-Link Corporation.

All rights reserved. This publication may not be reproduced, in whole or in part, without prior expressed written permission from D-Link Corporation.

Table of Contents

Product Overview	5	Audio and Video.....	32
Package Contents.....	5	Video Settings.....	32
Introduction	6	Image Settings.....	35
System Requirements.....	7	Audio Settings	37
Features.....	8	Day and Night Settings.....	38
Hardware Overview	9	Network.....	39
microSD Card Installation.....	11	IP Settings.....	39
Cable Connectors	12	Port and Access Name Settings.....	42
Installation	13	Dynamic DNS	45
Hardware Installation.....	13	HTTPS.....	46
Assembly and Installation	13	Access List.....	48
Cable Connections.....	15	Advanced Settings	50
General Connection Using the 12 V DC Power		Event Management	54
Adapter.....	15	Motion Detection	54
Connection Using Power over Ethernet.....	16	Tamper Detection.....	56
Software Installation	17	DI and DO	57
Setup Wizard	17	Event Settings	58
Web-based Configuration Utility.....	22	Recording	64
Configuration	24	Recording Settings.....	64
Live Video	24	Local Storage.....	66
Client Setup	28	PTZ Control	68
Setup.....	29	Digital PTZ	68
Basic Setup.....	29	Lens Control.....	69
Advanced Setup.....	30	System	70
System Overview	31	User Settings	70
		Device Settings.....	71

Time and Date.....	72
Maintenance.....	73
Parameter List	74
Logs	75
Appendix A - Technical Specifications	76
Technical Specifications.....	76
Appendix B - Regulatory Information.....	79
Regulatory Information.....	79

Package Contents



DCS-7517 5 Megapixel Day & Night Outdoor Network Camera



CAT5 Ethernet Cable



Power Adapter*



CD-ROM with User Manual and Software



Mounting Plate



Alignment Sticker and Fixings Kit



Quick Installation Guide



*Depending on your region, a power adapter may not be included.

If any of the above items are missing, please contact your reseller.

Note: Using a power supply with a different voltage than the one included with your product will cause damage and void the warranty for this product.

Introduction

D-Link DCS-7517 5 Megapixel Day & Night Outdoor Network Camera is a professional surveillance and security solution for small, medium, and large enterprises alike. Equipped with an industry-leading 5 megapixel progressive scan CMOS sensor and H.264 compression, the DCS-7517 connects to a network to provide professional high-quality live video over the Internet. This camera is capable of capturing video in both dark and light environments thanks to its built-in IR LEDs and IR-cut removable (ICR) filter. The ICR filter can be manually applied via the web, or set to automatically adjust based on lighting conditions. This feature allows the camera to capture crisp color images during the daytime and detailed grayscale images at night or in or low-light conditions.

The DCS-7517 is equipped with a remote focus lens that controls the iris with extreme precision. It's built-in stepping motor maintains the iris opening at an optimal level at all times, resulting in superior image clarity and depth of field as well as image quality. Together with WDR enhancement, you can identify image details in extremely bright as well as dark environments.

The DCS-7517 is equipped with IP66 certified weatherproof housing designed for both indoor and outdoor applications. The built-in removable IR-cut filter and IR LEDs give the DCS-7517 the capability to view up to 30 meters at night. The ability to use Power over Ethernet (PoE) also allows it to be easily installed in a variety of locations without the need for supplemental power cabling. The built-in microSD card slot can be used as a local backup by storing important events on an easily retrievable microSD card.

The included D-Link D-ViewCam™ is sophisticated software which allows users to manage up to 32 network cameras, set e-mail alert notifications, create recording schedules, and use motion detection to record directly to a hard drive. D-ViewCam™ also allows users to upload a floor plan to create a realistic layout of the premises where cameras are located, further simplifying the management process.

System Requirements

Network Requirements	<ul style="list-style-type: none">• An Ethernet-based network
DCS-7517 Web-based Configuration Utility Requirements	<p>Computer with the following:</p> <ul style="list-style-type: none">• Windows®, Macintosh, or Linux-based operating system• An installed Ethernet adapter <p>Browser Requirements:</p> <ul style="list-style-type: none">• Internet Explorer® 7 or higher• Mozilla Firefox 19 or higher
D-ViewCam Configuration Utility Requirements	<p>Computer with the following:</p> <ul style="list-style-type: none">• Microsoft Windows® 10/8/7/Vista/XP/2000• At least 256 MB of memory (512 MB recommended)• VGA card resolution: SVGA or XGA (1024x768 or above)• CPU: 1.7 GHz or above (2.8 GHz processor or faster with 512 MB memory and a 32 MB video card is required for multiple camera viewing and recording in D-ViewCam)

Features

Remote Focus Lens

The DCS-7517 allows quick and accurate remote focusing of the lens via the easy-to-use web configuration interface, which ensures that wherever you are, you can always maintain a sharp and clear image.

DC-iris

The DC-iris lens in the DCS-7517 solves the long-standing problem of capturing sharp images in varying light conditions. The the DCS-7517 optimizes the iris opening under all lighting conditions, resulting in images with better contrast, clarity, resolution and depth of field with improved image sharpness and increased image usability for network video surveillance.

Flexible Connectivity

The DCS-7517 includes input and output ports for connectivity to external devices such as IR sensors, switches, and alarm relays. The DCS-7517 also incorporates Power over Ethernet (PoE), allowing it to be easily installed in a variety of locations without the need for supplemental power cabling.

High-Quality Video at HD Resolution

The DCS-7517 provides real-time video feeds at up to 15 fps with 2560x1920 resolution and 30 fps with Full HD resolution. H.264 encoding ensures that images remain crisp, clear, and vivid without taking up too much network bandwidth.

Wide Dynamic Range

Wide Dynamic Range technology neutralizes imperfect lighting, providing clear images with the right amount of contrast even when a subject is backlit.

Weatherproof with Tamper Detection

Designed to be mounted outdoors, the DCS-7517 includes an IP66 certified enclosure which protects against the elements. Anti-tamper features make this camera suitable for tamper-prone locations such as transportation hubs, schools, or correctional facilities. The electronic tamper detection system can sense whenever the camera has been redirected, de-focused, blocked, or spray-painted, and can respond promptly with a visible or audible alarm.

Remote Monitoring Utility

The D-ViewCam application adds enhanced features and functionality for the Network Camera and allows administrators to configure and access the Network Camera from a remote site via Intranet or Internet. Other features include image monitoring, recording images to a hard drive, viewing up to 32 cameras on one screen, and taking snapshots.

Hardware Overview

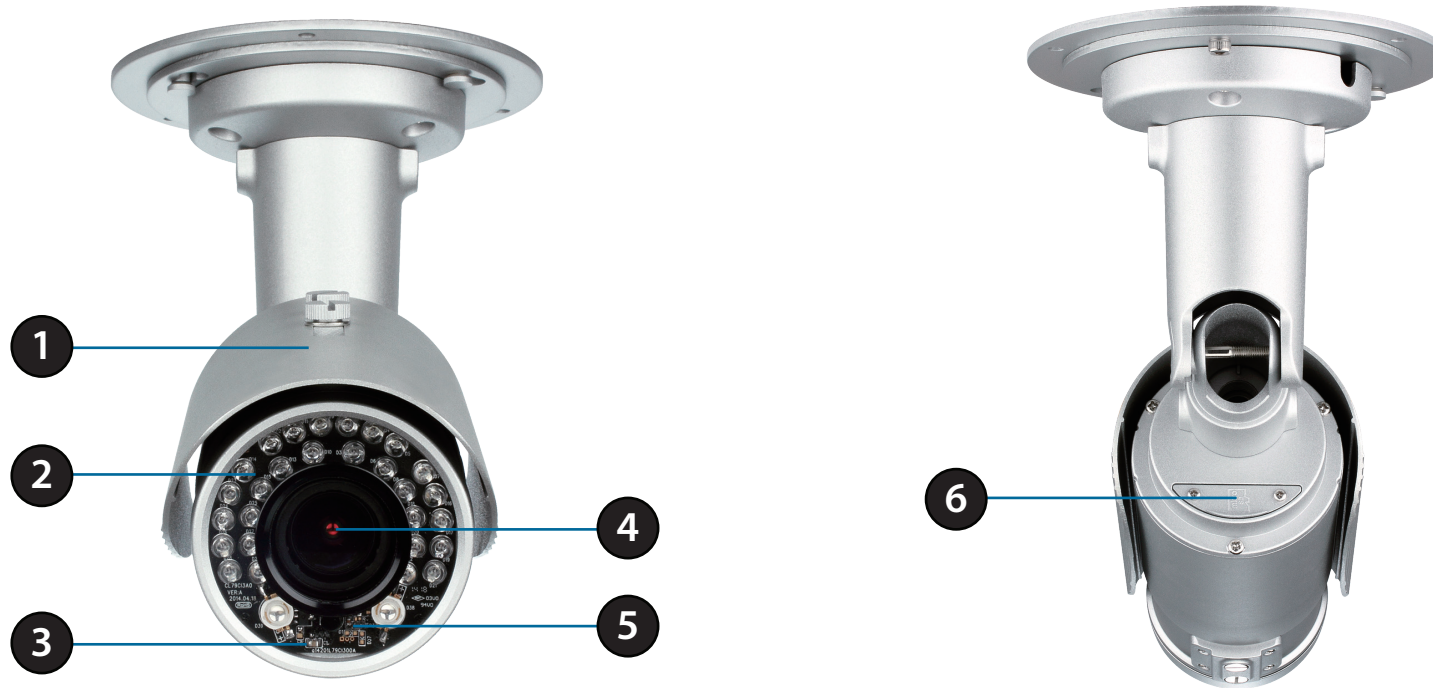

1	Weatherproof Casing	The camera is housed in an IP66 certified weatherproof casing, which protects it against rain and dust.
2	IR LEDs	Infrared LEDs illuminate the camera's field of view at night.
3	Power/Status LED	Red: The camera is receiving power but does not have a network connection. Green: The camera is receiving power and has a network connection. Flashing Green: The camera is transmitting data across the network.
4	Camera Lens	Varifocal lens to record video of the surrounding area.
5	Light Sensor	The light sensor measures the lighting conditions and switches between color and infrared accordingly.
6	microSD Card Cover	Unscrew to remove/change the camera's microSD card.

Hardware Overview



1	Sunshield	Shields the camera sensor from direct sunlight.
2	Adjustment Screw	Allows repositioning of the sunshield.
3	Camera Shoe	Adjustable mounting seat.
4	Wire in Bracket	Assembles tightly and protects the cables from outdoor wear and tear.

microSD Card Installation

Open the microSD Card Cover

Unscrew the microSD card cover and pull it down to open it.

Install the microSD Card

Push the microSD card into the camera with the gold contacts oriented towards the base of the camera. To eject, push the microSD card into the slot.

Note: Make sure that the weatherproof seals are secured firmly in place when reattaching the microSD card cover.

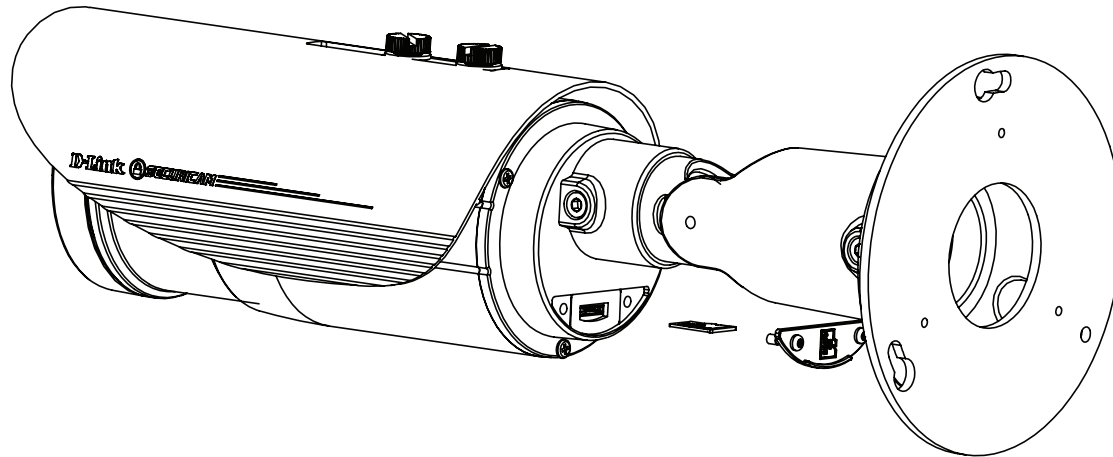

Cable Connectors

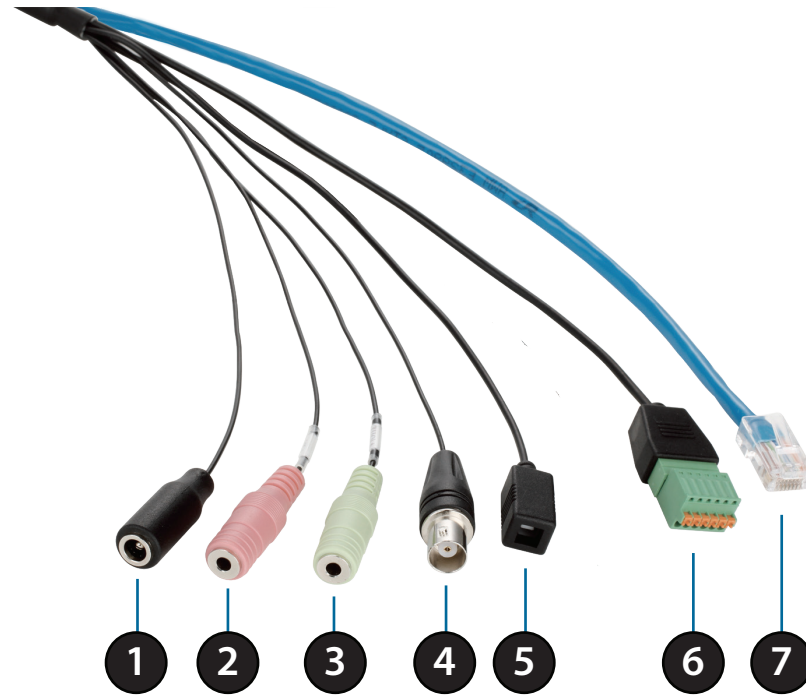

1	Power Connector	Power connector for the provided 12V DC power adapter.
2	Audio In (Red)	Connects to a microphone.
3	Audio Out (Green)	Connects to a speaker.
4	BNC Connector	The BNC connector is recommended for use with handheld monitors to check the camera's field of view during installation.
5	Reset Button	Press and hold the recessed button for 10 seconds to reset the camera back to the factory default settings.
6	DI/DO Connector	I/O connectors for external devices.
7	Ethernet Jack	Connects to an RJ45 Ethernet port. Can be used with PoE to provide power to the camera.

Hardware Installation

Assembly and Installation

It is highly recommended that you configure and test your camera before mounting it.

Step 1

Place the alignment sticker where you want to position the camera. Make sure the camera base will be positioned so that the cable channel is on the bottom.

Step 2

Use a 6 mm drill bit to make the required holes approximately 25 mm deep, then insert the wall anchors into the holes. If you are running the camera cables through the wall, drill a hole in the center and pull the cables through the hole.

Step 3

Use the screws provided to mount the camera to the wall. If you are running the camera cables out the side of the camera, guide the camera cables through the cable channel on the base.

Step 4

Connect the power and Ethernet cables, or just the Ethernet cable if you are using a PoE connection.

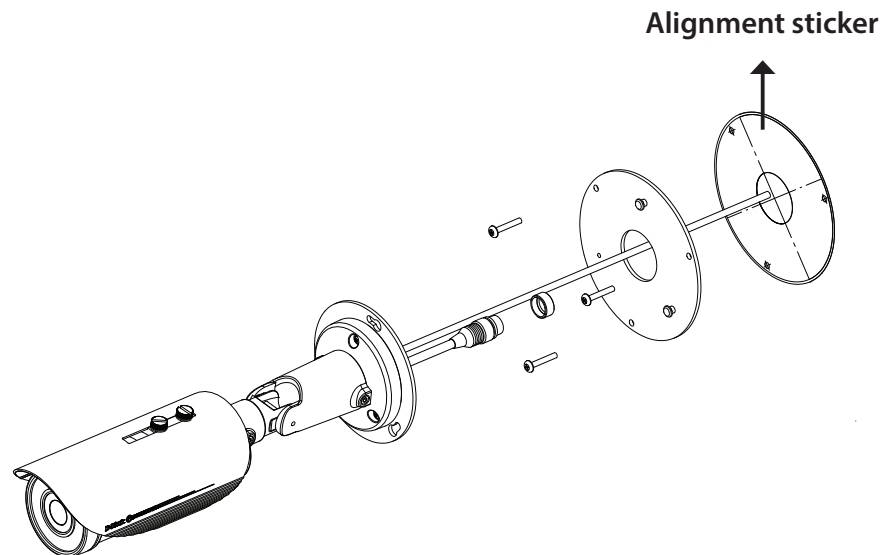

Installation

If the cable bundle is not required, it can be detached from the camera, and the socket sealed with a weatherproof cable cover.

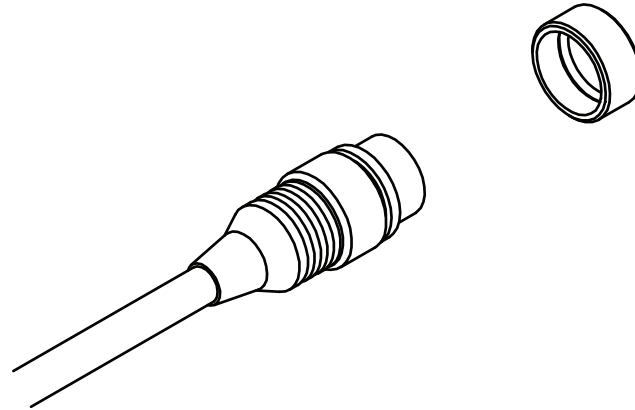

To adjust the camera's angle, turn the adjustment ring counterclockwise to loosen it, then move the camera to the desired position and angle. When you are finished, turn the adjustment ring clockwise to tighten it.

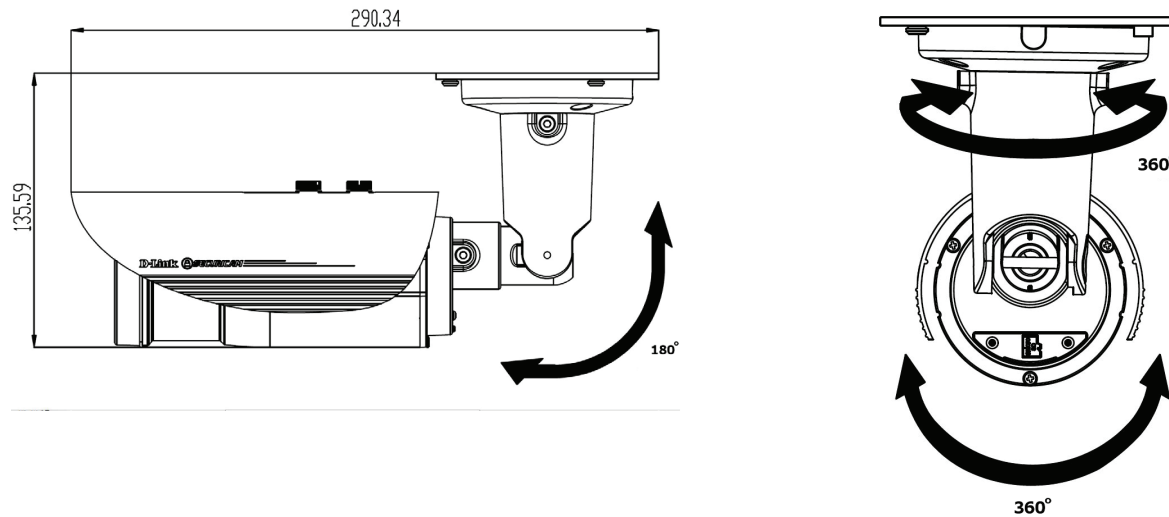

Cable Connections

General Connection Using the 12 V DC Power Adapter

Step 1

Connect the network camera to a switch via an Ethernet cable.

Step 2

Connect the supplied power adapter to the camera's power connector, then plug the adapter into a power outlet.

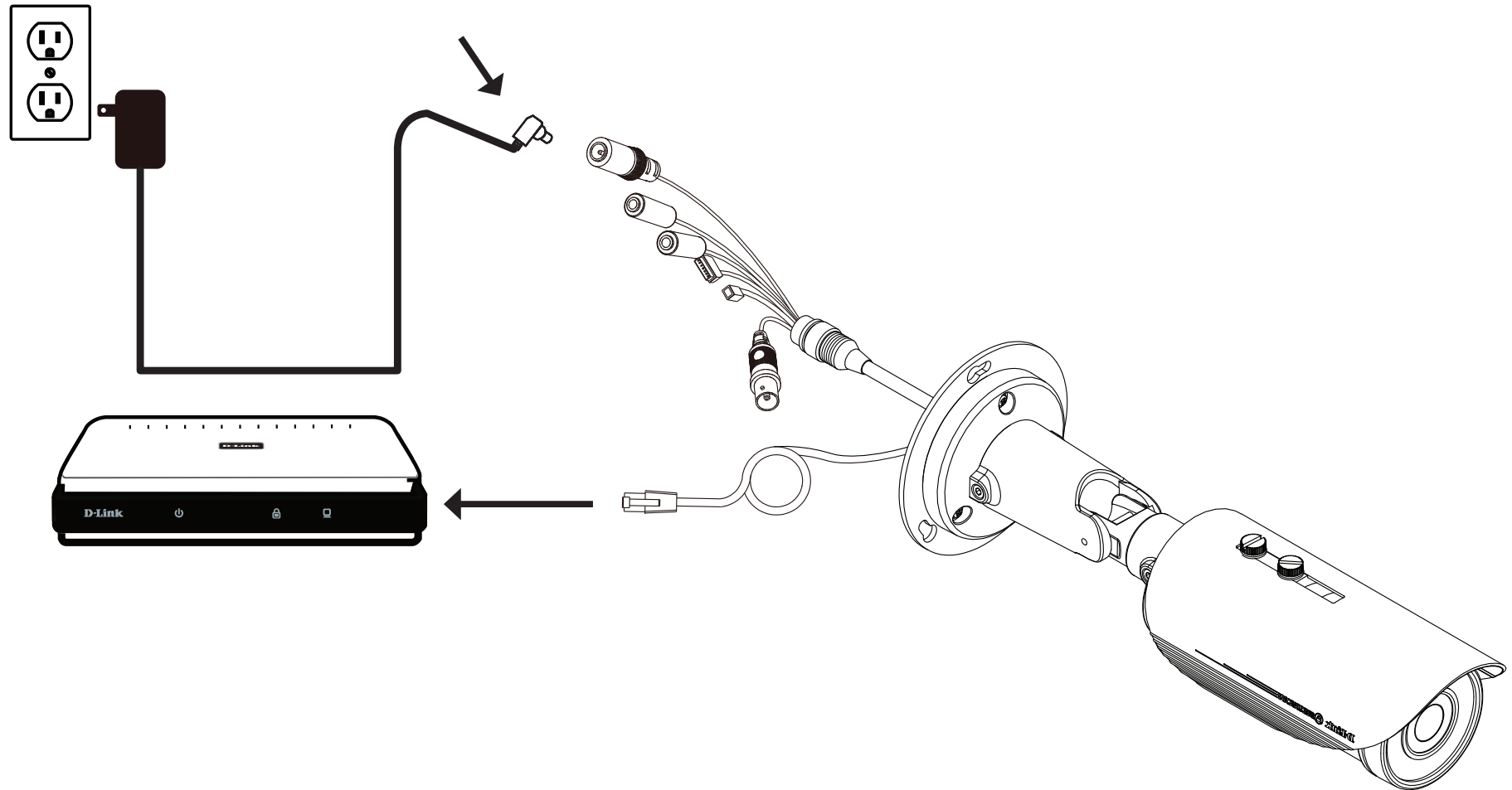

Connection Using Power over Ethernet

Step 1

If you are using a PoE switch, connect the IP camera to the PoE switch via an Ethernet cable, which will provide transmission of both power and data over a single cable.

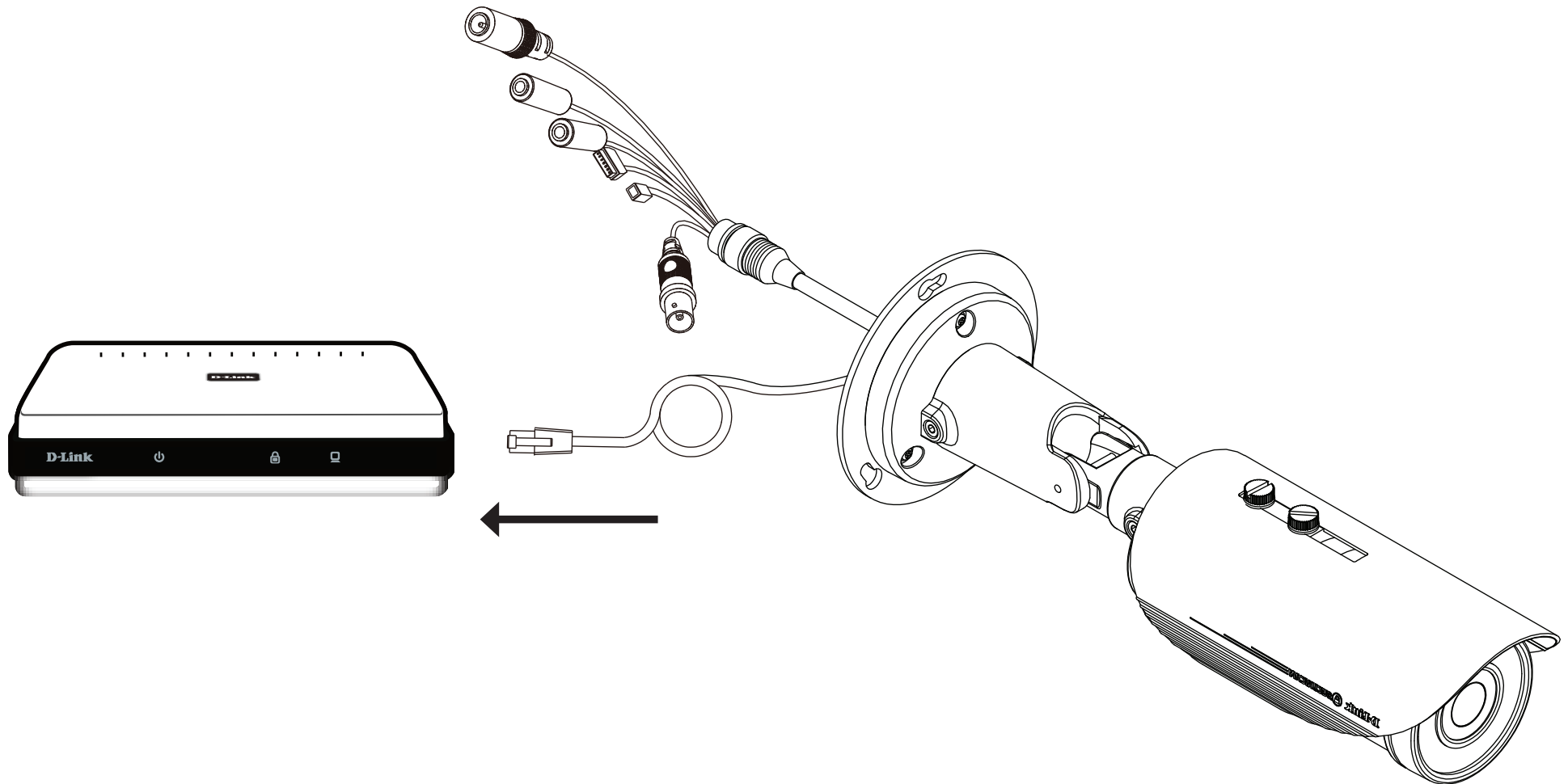

Software Installation

Setup Wizard

Insert the DCS-7517 CD into your computer's CD-ROM drive to begin the installation. If the Autorun function on your computer is disabled, or if the D-Link Launcher fails to start automatically, click the Start button and type **D:\autorun.exe** (where D: represents the drive letter of your CD-ROM drive) and press Enter.

Click **Setup Wizard** to begin the installation.

After clicking Setup Wizard, the window on the right will open.

Click **Next** to continue.

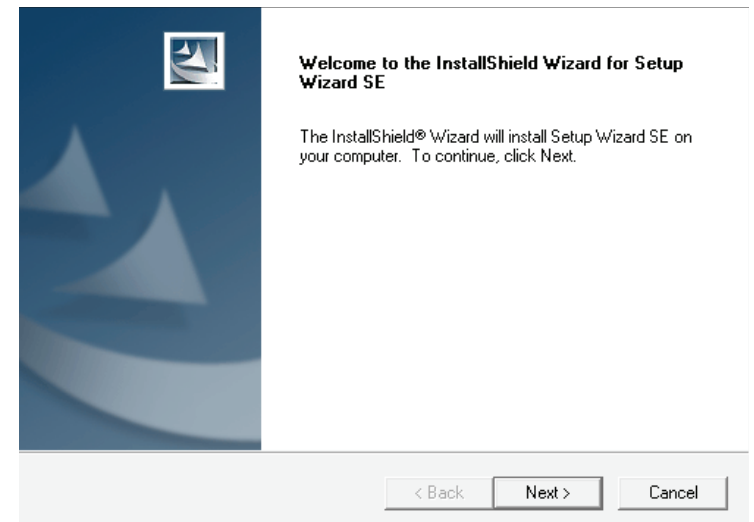

Installation

Click **Yes** to accept the License Agreement.

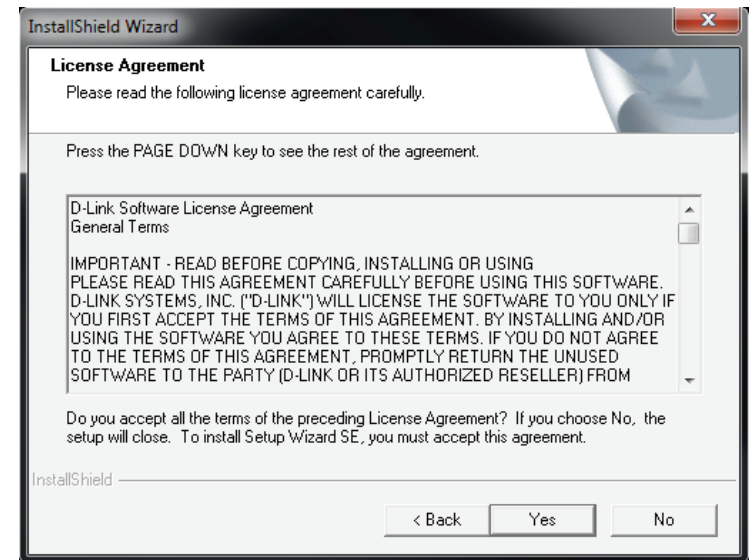

Click **Next** to start the installation process.

Note: The installation may take several minutes to finish.

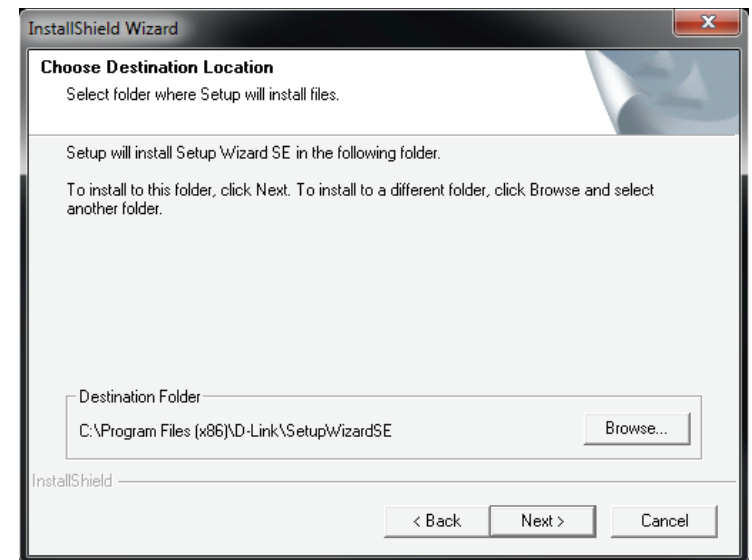

Installation

Click **Finish** to complete the installation.

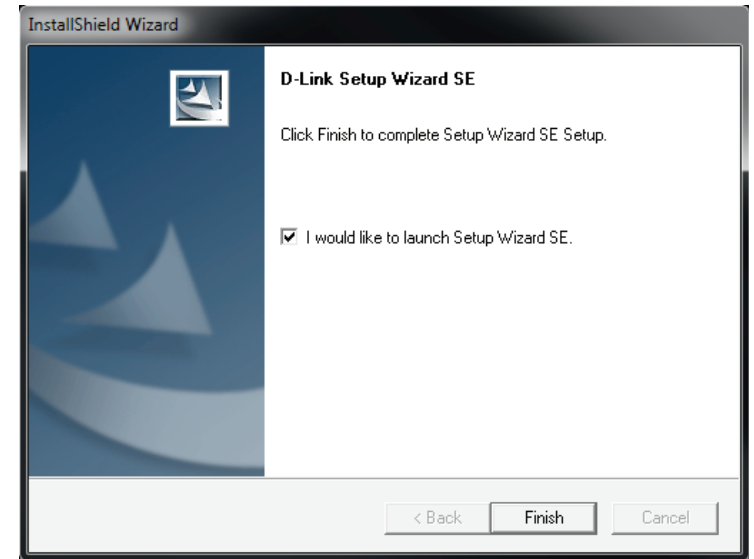

Click on the **D-Link Setup Wizard SE** icon that was created in your Windows Start menu.

Start > D-Link > Setup Wizard SE

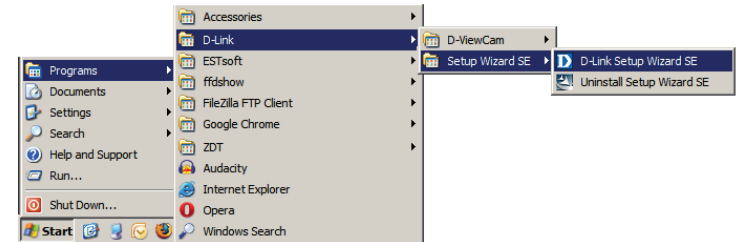

Installation

The Setup Wizard will appear and display the MAC address and IP address of your camera(s). If you have a DHCP server on your network, a valid IP Address will be displayed. If your network does not use a DHCP server, the network camera's default static IP address (**192.168.0.20**) will be displayed.

Select your camera and then click the **Wizard** button to continue.



Enter the Admin ID and password. When logging in for the first time, the default Admin ID is **admin** with the password left blank.

Click **Next** to continue.

Set up an Admin ID and Password to secure your camera.
Click Next to continue.

Admin ID Password

Change

New ID New Password

Reconfirm Reconfirm

Installation

Select **DHCP** if your camera obtains an IP address automatically from a DHCP server such as a router. Select **Static IP** if you want to manually enter the IP settings for the camera.

Click **Next** to continue.



The screenshot shows the 'Set IP Address' configuration page in the D-Link Securicam Network web interface. The page has a blue header with the D-Link logo and 'SECURICAM Network' text. The main content area is light gray. At the top, there are two radio buttons: 'DHCP' (unselected) and 'Static IP' (selected). Below this, there are six input fields for network settings, each with a label and a text box containing a value:

Field	Value
IP Address	192.168.1.66
Subnet Mask	255.255.255.0
Default Gateway	192.168.1.254
Primary DNS	168.95.1.1
Secondary DNS	168.95.192.1

At the bottom right, there are three buttons: 'Back' (left arrow), 'Next' (right arrow), and 'Exit' (red square with white 'I').

Take a moment to confirm your settings and click **Restart**.



The screenshot shows the same configuration page as above, but now with an additional 'Admin ID' field at the top, containing the value 'admin'. The other network settings remain the same. Below the input fields, there is a block of text:

Now you have configured all settings. Please click button 'Restart' to commit the settings to the Internet camera and reboot it. Or, you can click button 'Back' to change the settings again.

At the bottom right, there are two buttons: 'Back' (left arrow) and 'Restart' (circular refresh icon).

Web-based Configuration Utility

This section explains how to configure your new D-Link Network Camera using the Web-based Configuration Utility.

Click on the **D-Link Setup Wizard SE** icon that was created in your Windows Start menu.

Start > D-Link > Setup Wizard SE

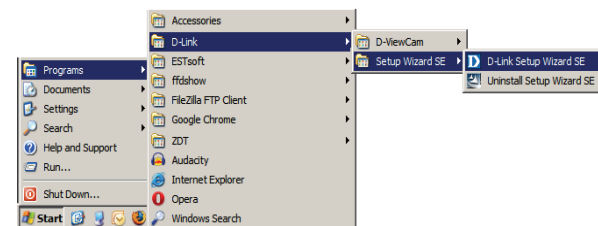

Select the camera and click **Link** to access the web configuration.

The Setup Wizard will automatically open your web browser to the IP address of the camera.



Installation

Enter **admin** as the default username and leave the password blank. Click **OK** to continue.





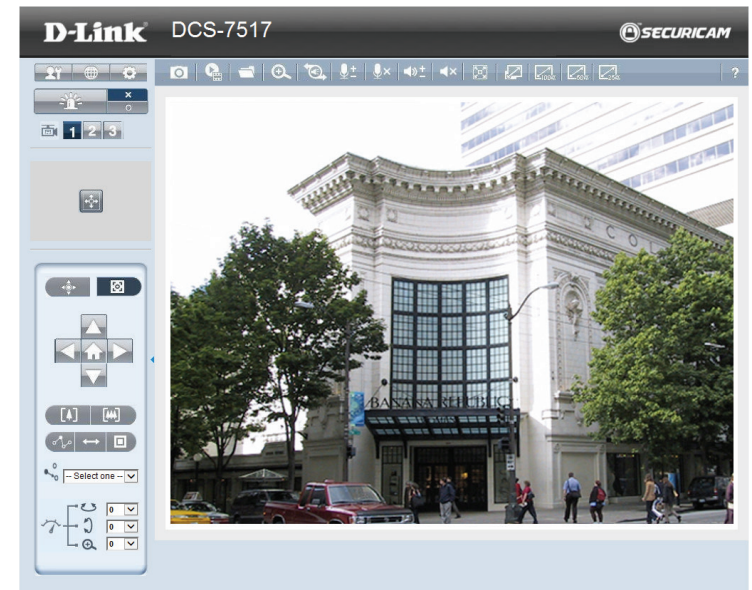



This section shows your camera's live video. You can select your video profile and view or operate the camera.

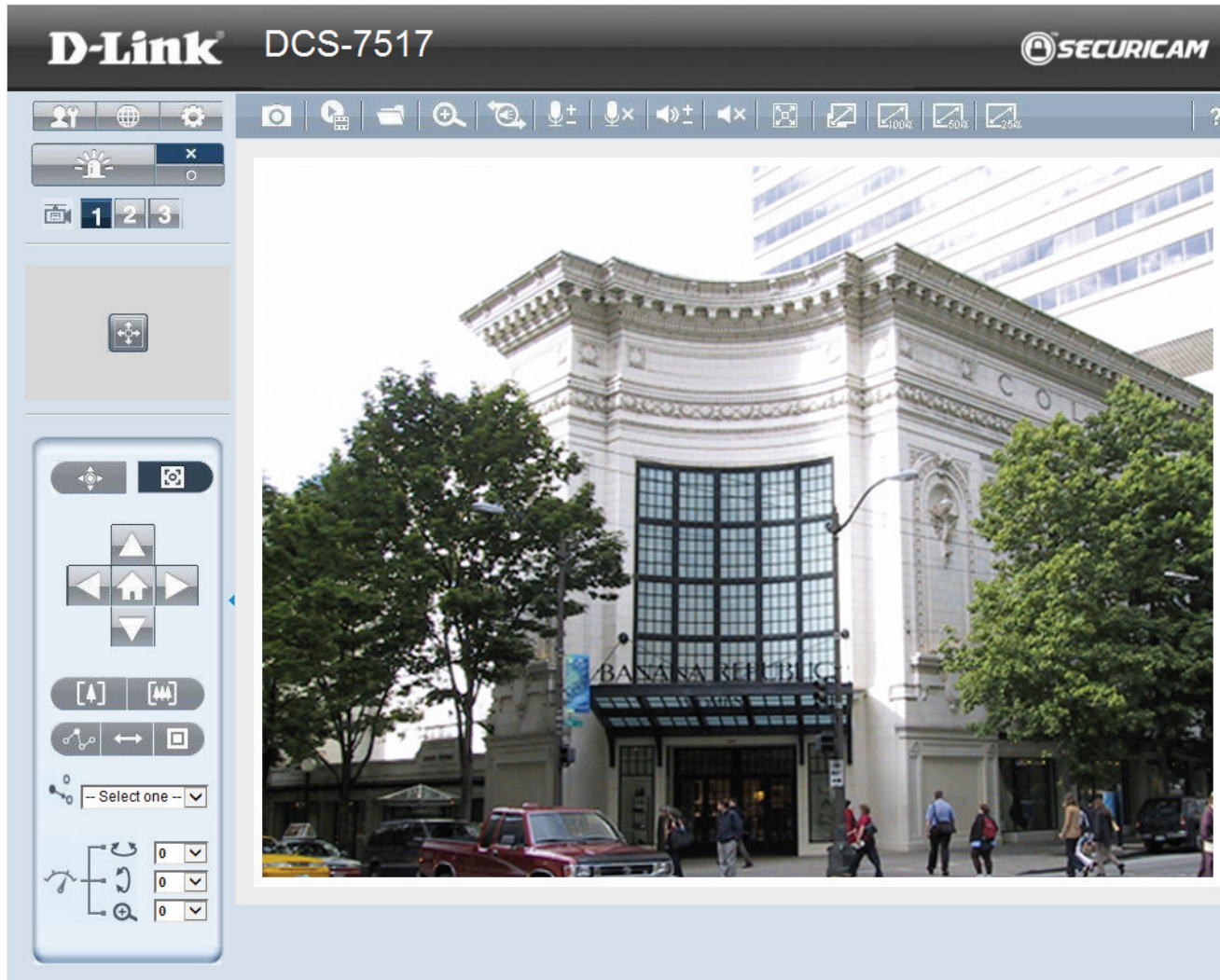





Live Video

When you connect to the camera's web interface you will see the following page. This is the Live Video page which will allow you to view the camera's video feed and control basic camera functions using the icons on the screen. Please refer to the tables on the following pages for detailed information about the icons on this screen.

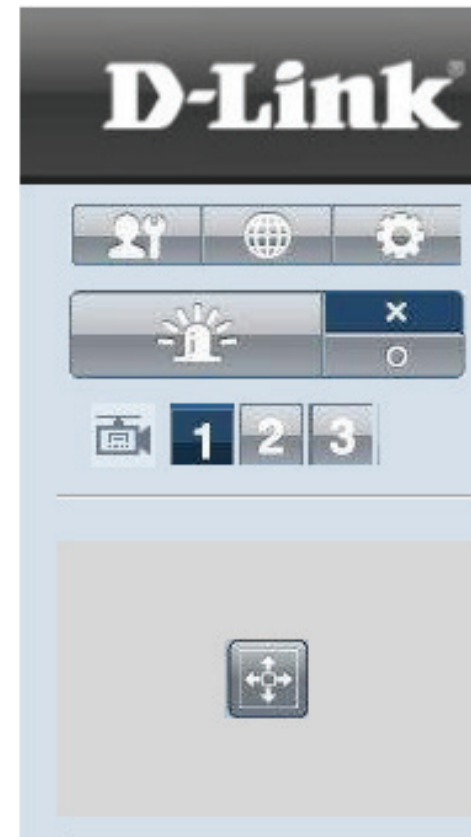

 <p>Client Settings</p>	<p>Set up the stream transmission mode and saving options on the local computer.</p>
 <p>Language</p>	<p>Select this option to adjust the language settings.</p>
 <p>Setup</p>	<p>Click to edit the camera's settings. Note that only Administrators can access the setup page. To simplify the setting procedure, two types of user interfaces are available: Advanced Setup for professional users and Basic Setup for entry-level users.</p>
 <p>Digital Output</p>	<p>Click this button to turn the digital output device on or off.</p>
 <p>Video Stream</p>	<p>This camera supports multiple streams (stream 1 ~ 3) simultaneously. You may select one for live viewing.</p>
 <p>Global View</p>	<p>Click on this item to display the Global View window. The Global View window contains a full view image (the largest frame size of the captured video) and a floating frame (the viewing region of the current video stream). The floating frame allows users to control the e-PTZ function (Electronic Pan/Tilt/Zoom). For more information about e-PTZ operation, please refer to PTZ Control on the next page. For more information about how to set up the viewing region of the current video stream, please refer to Video settings on page 32.</p>



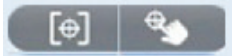
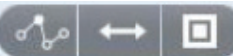
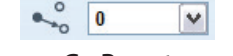
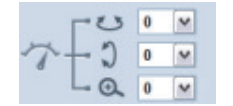



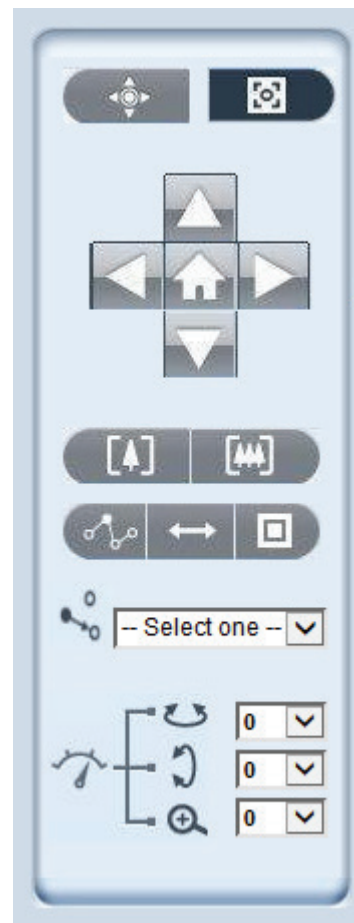







 <p>PTZ Control</p>	<p>This camera supports both digital (e-PTZ) and mechanical zoom control.</p> <p>Mechanical Z: Controls the mechanical zoom. Digital PTZ: Controls the e-PTZ operation.</p>
 <p>ePT Direction</p>	<p>Home: Moves the camera to the preset home position. Direction: Controls the camera's pan or tilt directions (up/down/left/right).</p>
 <p>Zoom</p>	<p>Zoom in: Zooms into the image. Zoom out: Zooms out of the image.</p>
 <p>Focus</p>	<p>Control camera focus to get a clear image. (Only available under Mechanical PTZ mode)</p> <p>Focus Near: Sets the depth of field zone closer. Focus Far: Sets the depth of field zone farther.</p>
 <p>Auto Focus/Home</p>	<p>Reset the camera focus, either by auto focus or to a pre-configured default.</p> <p>Auto Focus: Allows the camera to automatically adjust the focus. Home: Returns to the center of the viewing area.</p>
 <p>Patrol Auto Pan</p>	<p>Patrol: Moves through a pre-defined sequence of pan, tilt, zoom, and focus settings. Before selecting this, you must define at least two preset points.</p> <p>Auto Pan: Automatically scans an area horizontally. Stop: Stops patrol and auto pan.</p>
 <p>Go Preset</p>	<p>Select a preset from the drop-down list to quickly move the camera to the desired preset position.</p>
 <p>Speed Control</p>	<p>Control Pan/Tilt/Zoom speed: Please select a value between 0 and 10. 0 is the slowest and 10 is the fastest.</p> <p>Pan Speed Control Tilt Speed Control Zoom Speed Control</p>

Digital PTZ Control Panel



Mechanical Z Control Panel



 <p>Snapshot</p>	<p>Click this button to capture and save still images. The captured images will be displayed in a pop-up window. Right-click the image and select Save Picture As to save it in JPEG (*.jpg) or BMP (*.bmp) format.</p>
 <p>Recording</p>	<p>Click this button to record video clips to your computer. When close your web browser, video recording stops accordingly.</p>
 <p>Recording Folder</p>	<p>Specify a storage destination for the recorded video files.</p>
 <p>Digital Zoom</p>	<p>Click and uncheck "Disable digital zoom" to enable the zoom operation. The navigation screen indicates the part of the image being magnified. To control the zoom level, drag the slider bar. To move to a different area you want to magnify, drag the navigation screen.</p>
 <p>Two Way Audio</p>	<p>Click this button to enable or disable two way audio communication.</p>
 <p>Mic Volume</p>	<p>Click this button to raise or lower the volume of the attached microphone.</p>
 <p>Mic Mute</p>	<p>Click this button to completely mute the attached microphone.</p>
 <p>Speaker Volume</p>	<p>Click this button to raise or lower the volume of the attached speaker.</p>
 <p>Speaker Mute</p>	<p>Click this button to completely mute the attached speaker.</p>
 <p>Full Screen</p>	<p>Click this button to switch to full screen mode. Press the "Esc" key to switch back to normal mode.</p>
 <p>Zoom ratio</p>	<p>Auto: The video zoom ratio will be changed automatically according to viewing window size. 100%: Keep the video zoom ratio at 100% 50%: Keep the video zoom ratio at 50% 25%: Keep the video zoom ratio at 25%</p>
 <p>Help</p>	<p>Click the Help button to learn the detailed information regarding camera setup and solve any problems you encounter.</p>

Client Setup

Clicking the Client Settings button  will bring you to the following screen which allows you to configure the basic protocol options for your camera.

H.264 Media Options

For additional information about streaming options please refer to "Audio and Video" on page 32.

Recording Options

Folder: Select the folder where you would like the Recording file saved on your computer.

File name prefix: Enter a file name prefix for the Recording files.

Add date and time suffix to file name: Select this checkbox if you would like the date and time to be added to the end of each filename.

Local Streaming Buffer Time

Enter the buffer time in milliseconds. The buffer will cause a slight delay between live activity and the video of the live stream but may increase the quality of video.

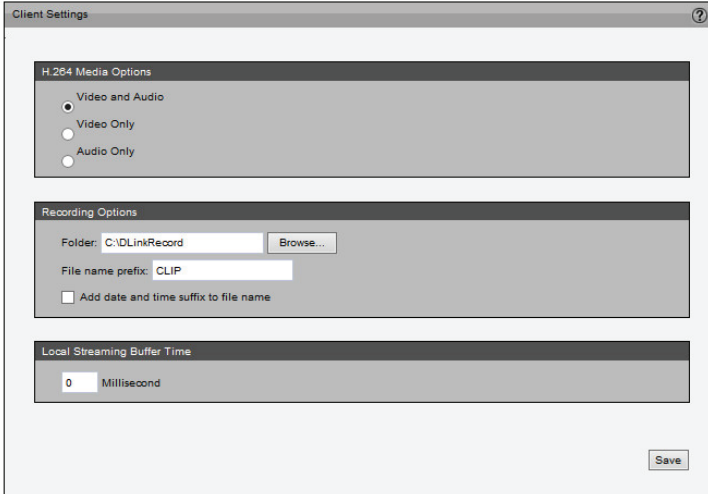

The screenshot shows the 'Client Settings' window with three main sections:

- H.264 Media Options:** Three radio buttons are visible: 'Video and Audio' (selected), 'Video Only', and 'Audio Only'.
- Recording Options:** A 'Folder:' field contains 'C:\DLinkRecord' with a 'Browse...' button. Below it, a 'File name prefix:' field contains 'CLIP'. A checkbox labeled 'Add date and time suffix to file name' is currently unchecked.
- Local Streaming Buffer Time:** A numeric input field contains '0' followed by the unit 'Millisecond'.

A 'Save' button is located in the bottom right corner of the window.

Setup

The DCS-7517 includes basic and advanced setup screens. Both screens include a tree view with multiple setup options. This manual includes detailed explanations for all advanced setup screens.

Basic Setup

Click the **Setup** button to enter the setup screen.



Click on the **Basic** button to enter the Basic Setup screen.



Please click the [+] next to each folder to view the options inside.

Basic Setup includes the following options:

System Overview

Audio and Video

- Video Settings
- Audio Settings

Network

- IP Settings

Event Management

- Motion Detection
- Tamper Detection

PTZ Control

- Digital PTZ

System

- User Settings
- Device Settings
- Time and Date
- Maintenance

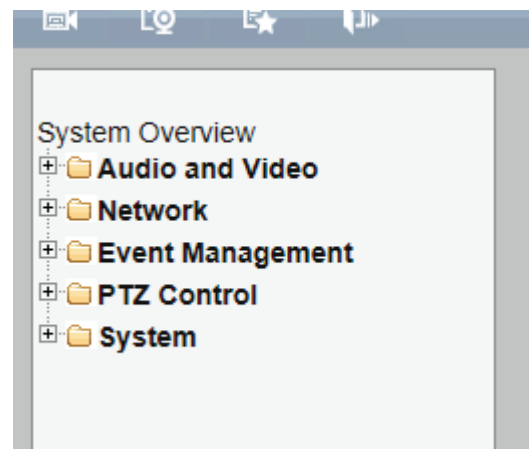

Advanced Setup

Click the **Setup** button to enter the setup screen.



Click on the **Advanced** button to enter the Advanced Setup screen.



Please click the [+] next to each folder to view the options.

Advanced setup includes the following options:

System Overview

Audio and Video

- Video Settings
- Image Settings
- Audio Settings
- Day and Night Settings

Network

- IP Settings
- Port & Access Name Settings
- Dynamic DNS
- HTTPS
- Access List
- Advanced Settings

Event Management

- Motion Detection
- Tamper Detection
- DI and DO
- Event Settings

Recording

- Recording Settings
- Local Storage

PTZ Control

- Digital PTZ
- Lens Control

System

- User Settings
- Device Settings
- Time and Date
- Maintenance
- Parameter List
- Logs

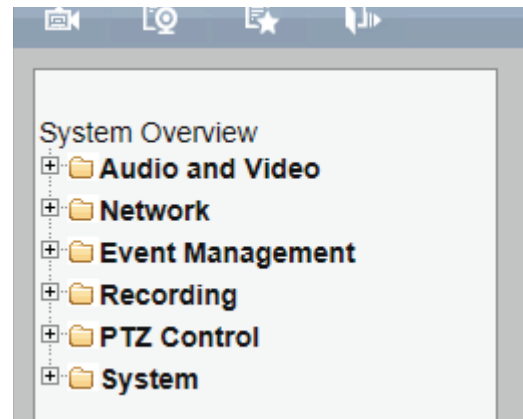

System Overview

The system overview page contains a summary of the camera's current settings.

System Overview ?

Device Information

IP address	192.168.1.66
Link-local address	169.254.113.253
Current firmware version	v1.10.03
Current firmware date	26 Feb 2015
Hardware version	A
Model name	DCS-7517
MAC address	00:0F:0D:00:30:85
Connect client	0

Time and Date

Current system time	16 Apr 2015 14:31:36
System up time	0 Days, 2 Hours, 24 Minutes
Time mode	NTP

Service Status

Service	Enabled / Disabled	Protocol	Server port
HTTP	Enable	TCP	8081
Secondary HTTP	Enable	TCP	8080
HTTPS	Disable	TCP	443
RTSP	Enable	TCP	554
UPnP presentation	Enable	-	-
UPnP port forwarding	Disable	-	-
802.1x	Disable	-	-
CoS	Disable	-	-
QoS / DSCP	Disable	-	-
SNMP	Disable	-	-
DDNS	Disable	-	-
Access list	Disable	-	-

Stream Status

Stream number	Codec type	Resolution	Max Frame Rate	Bitrate / Quality
Stream 1	H.264	2560x1920	15	6 Mbps
Stream 2	H.264	640x400	15	512 Kbps
Stream 3	H.264	640x400	7	128 Kbps
Stream 4	H.264	2560x1920	15	1 Mbps

Recent Logs

```

[ 2015/04/16 14:30:20 ] 192.168.1.100 login by admin.
[ 2015/04/16 12:06:54 ] 192.168.1.100 login by admin.
[ 2015/04/16 12:06:40 ] System boot.
[ 2015/04/16 12:01:29 ] 192.168.1.100 login by admin.
[ 2015/04/16 10:29:43 ] System boot.
[ 2015/03/02 13:53:13 ] 192.168.1.76 login by admin.
[ 2015/03/02 12:00:56 ] 192.168.1.76 login by admin.
[ 2015/03/02 11:36:10 ] 192.168.1.76 login by admin.
[ 2015/03/02 08:30:13 ] 192.168.1.76 login by admin.

```

Audio and Video

Video Settings

This page allows you to set up three video streams to be displayed on a computer, mobile device, or storage system. Each stream has independent options for compression type, frame size, frame rate to optimize the bandwidth utilization and video quality.

Video Options

Viewing Window: The camera supports multiple streams with frame sizes ranging from 960x540 to 2560x1920. Click **Viewing Window** to open the viewing region setting page. On this page, you can set the Region of Interest (ROI) and the Output Frame Size for stream 1~3.

Please follow the steps below to set up a stream:

1. Select a stream with a viewing region you would like to set.
2. Select a Region of Interest from the drop-down list, and the floating frame will resize accordingly. If you want to set up a customized viewing region, you can also resize and drag the floating frame to a desired position with your mouse.
3. Choose an Output Frame Size from the drop-down list according to the size of your monitoring device.

Note: The "Output Frame Size" you choose should not be greater than the selected "Region of Interest".

Defining the streams:

Stream 1-3: You can define the "Region of Interest" (viewing region) and the "Output Frame Rate" (size of the live view window) for each stream.

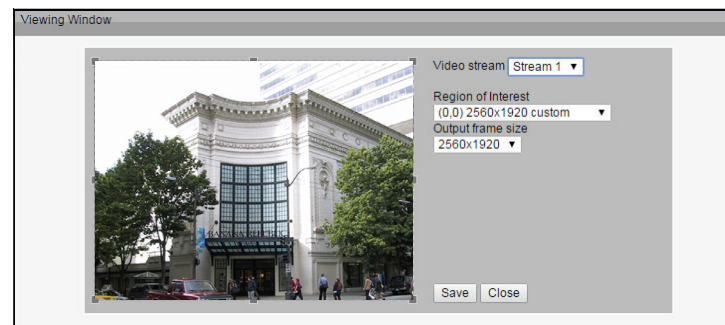
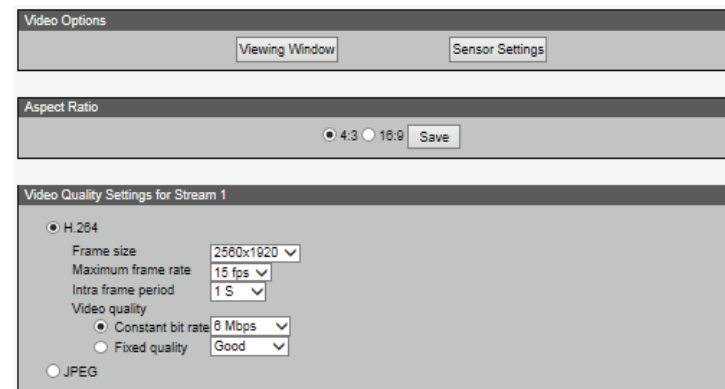

After adjusting settings for the Viewing Window, click **Save** to enable the settings and click **Close** to exit the window. The selected Output Frame Size will immediately be applied to the frame size of video stream. You can then go back to the Live Video page to test the new settings.

Sensor Setting: Click **Sensor Setting** to open the Sensor Setting page. On this page, you can set the maximum exposure time, exposure level, and AGC (Auto Gain Control) settings. You can configure two sets of sensor settings: one for normal situations, and one for special situations such as when using day/night/schedule mode.

Exposure

- **Maximum Exposure Time:** Select the desired maximum exposure time based on the lighting conditions of the area being monitored. Longer exposure times will improve exposure for dark environments, but may result in moving objects appearing blurred. The maximum exposure time can be set to 1/120 second, 1/60 second, 1/30 second, 1/15 second, or 1/5 second.
- **Exposure level:** You can manually set the Exposure level from 1 to 8 (dark to bright).
- **Max. Gain (Auto Gain Control):** You can manually set the AGC level to 2X, 4X, 8X, 16x, or 32x. The higher the value, the more gain will be applied and the brighter the image will be.

You may click **Preview** to fine-tune the image, or click **Restore** to recall the previous settings without saving your changes. When you are finished changing the settings on this page, click **Save** to save your changes and click **Close** to exit the page. If you want to configure another sensor setting for day/night/schedule mode, please click **Profile 2** and follow the steps below to setup:

1. Click Enable this profile.
2. Select the mode to use: Day mode, Night mode, or Schedule mode. Please manually enter a range of time if you choose Schedule mode.
3. Configure the Exposure settings in the second column.
4. Click **Save** to save your changes and click **Close** to exit the page.

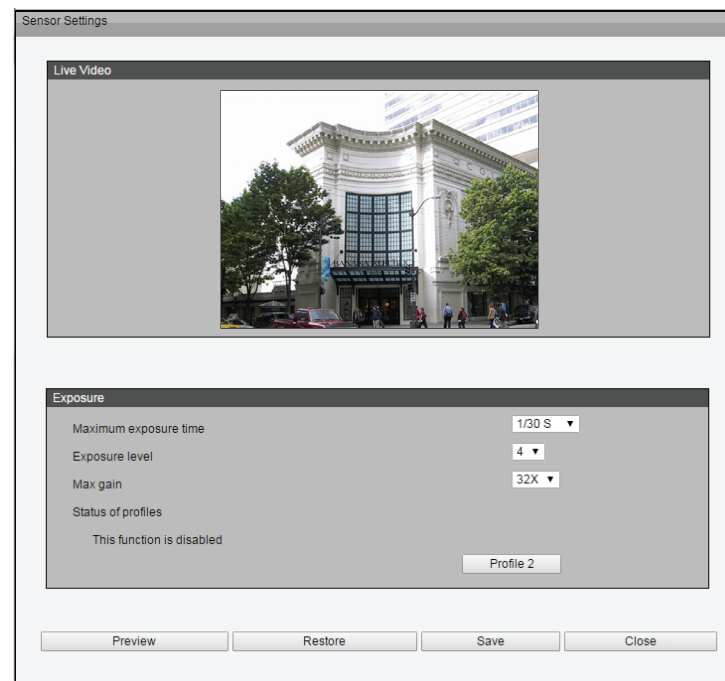
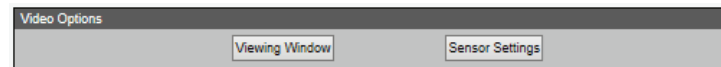

Aspect Ratio

Choose either 4:3 or 16:9 for the aspect ratio. This will format the video stream to better fit the type of display that it will be viewed on. 4:3 is better for standard definition displays, while 16:9 is meant for displays that are capable of showing wide format content.

Video Quality Settings for Stream 1~3

Compression Type: The compression level affects the amount of bandwidth and storage required. Lower compression uses more bandwidth and storage but delivers better image quality. Of the two options, H.264 consumes much less network bandwidth compared to JPEG.

Frame Size: Select a frame size from the drop-down menu; a bigger frame size requires more bandwidth and storage. For smaller viewers such as mobile phones, a smaller frame size and lower frame rate is recommended.

Frame Rate: This option affects the smoothness of the video. Higher frame rates provide smoother video quality but require more storage. You can set the frame rate to customize, 1, 2, 3, 5, 8, 10, 15, 20, 25, or 30 fps. The frame rate may automatically change and some options may not be available depending on the resolution. The max. frame rate when using a 4:3 aspect ratio is 15 fps.

Intra Frame Period: Sets the interval between I-frames. The shorter the interval, the more likely you will get better video quality, but at the cost of higher network bandwidth consumption. You can set the intra frame period to 1/4 second, 1/2 second, 1 second, 2 seconds, 3 seconds, or 4 seconds.

Video Quality: This setting limits the maximum refresh frame rate.

- **Constant bit rate:** Sets a fixed bandwidth regardless of the video quality. Select Constant bit rate and a bandwidth from 20 Kbps to 8 Mbps. You can also select **Customize** and manually enter a value.
- **Fixed quality:** Optimizes bandwidth utilization and video quality. The video quality can be adjusted to one of the following settings: Medium, Standard, Good, Detailed, or Excellent. You can also select **Customize** and manually enter a value.

The screenshot displays a configuration interface for video streams. At the top, the 'Aspect Ratio' section has radio buttons for '4:3' (selected) and '16:9', with a 'Save' button. Below are four panels for 'Video Quality Settings for Stream 1', 'Stream 2', 'Stream 3', and 'Stream 4'. Each panel has a radio button for 'H.264' (selected) and 'JPEG'. For each stream, the following settings are shown: 'Frame size' (dropdown), 'Maximum frame rate' (dropdown), 'Intra frame period' (dropdown), and 'Video quality' (radio buttons for 'Constant bit rate' and 'Fixed quality', with dropdown menus for values). Stream 1: Frame size 2560x1920, Max frame rate 15 fps, Intra frame period 1 S, Constant bit rate 8 Mbps, Fixed quality Good. Stream 2: Frame size 1280x960, Max frame rate 5 fps, Intra frame period 1 S, Constant bit rate 2 Mbps, Fixed quality Good. Stream 3: Frame size 800x600, Max frame rate 5 fps, Intra frame period 1 S, Constant bit rate 1 Mbps, Fixed quality Good. Stream 4: Frame size 800x600, Max frame rate 5 fps, Intra frame period 1 S, Constant bit rate 1 Mbps, Fixed quality Good. A 'Save' button is located at the bottom right of the interface.

Image Settings

This page allows you to tune the white balance, brightness, saturation, contrast, and sharpness settings for the video.

Color: Select either a Color or B/W (black and white, monochrome) video display.

Power Line Frequency: Select either 50 or 60 Hz depending on your region.

Iris Mode: Select the environment that the camera will primarily be viewing. This can be set to Fixed, Indoor, or Outdoor.

Video Orientation: Flip will vertically rotate the video. Mirror will horizontally rotate the video. You may select both options if your camera is installed upside down.

White Balance: This adjusts the relative amount of red, green, and blue primary colors in the image so that neutral colors are reproduced correctly.

- **Auto:** The camera automatically adjusts the color temperature of the light in response to different light sources. The white balance setting defaults to Auto and works well in most situations.
- **Fixed:** Follow the steps below to manually set the white balance to compensate for ambient lighting conditions:
 1. Set the White balance to **Auto** and click **Save**.
 2. Place a sheet of white paper in front of the lens, then allow the camera to adjust the color temperature automatically.
 3. Select **Fixed** to confirm the setting while the white balance is being measured.
 4. Click **Save** to enable the new setting.

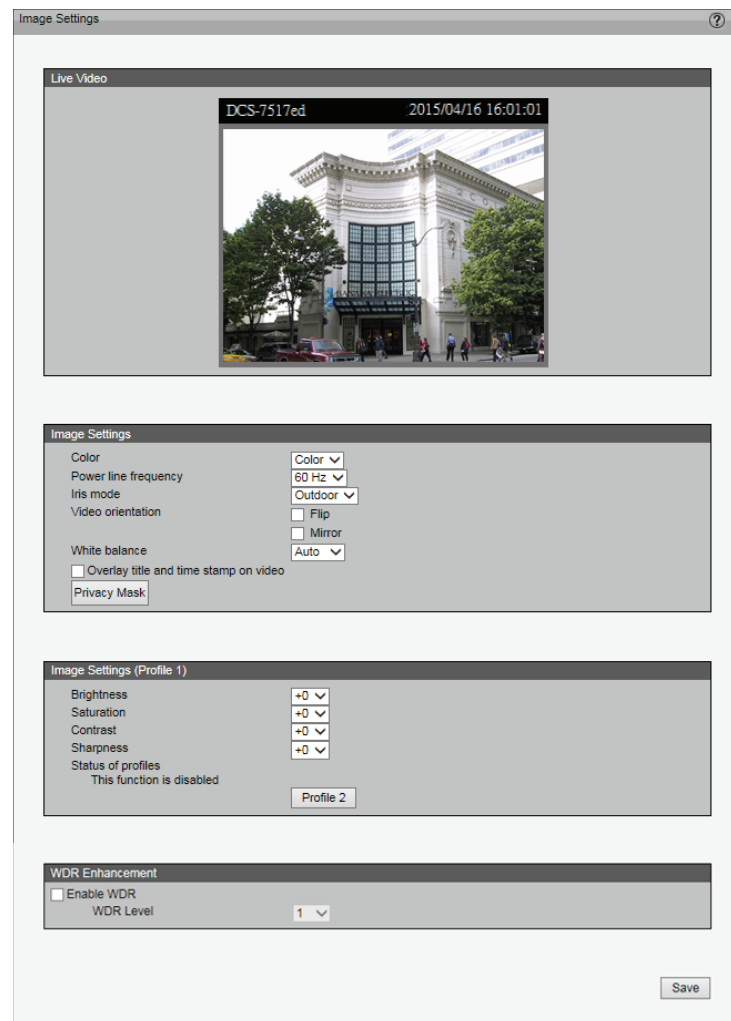

Brightness: Adjusts the image brightness level.

Saturation: Adjusts the image saturation level.

Contrast: Adjusts the image contrast level.

Sharpness: Adjusts the image sharpness level.

Overlay Title and Time Stamp on Video: Select this option to place the video title and time on the video streams. (When the frame size is set to 176 x 144, only the time will be stamped on the video streams.)

Privacy Mask: Here you can block out certain sensitive zones for privacy concerns. To set up a Privacy Mask Window, follow the steps given below:

1. Click **New** to add a window.
2. The height and width of the window can be resized by drag-and-dropping the window.
3. Enter a descriptive name for the window and click **Save** to apply the changes.
4. Select **Enable privacy mask** to enable this function.

None:

- Up to 5 privacy mask windows can be set up on the same screen.
- If you want to delete a privacy mask window, please click the 'x' at the upper right-hand corner of the window.

Enable WDR: Enabling Wide Dynamic Range (WDR) can improve the exposure of the image when the lighting in the area varies significantly.

WDR Level: Specify a value from 0 to 10 to specify how much WDR to apply to the image.

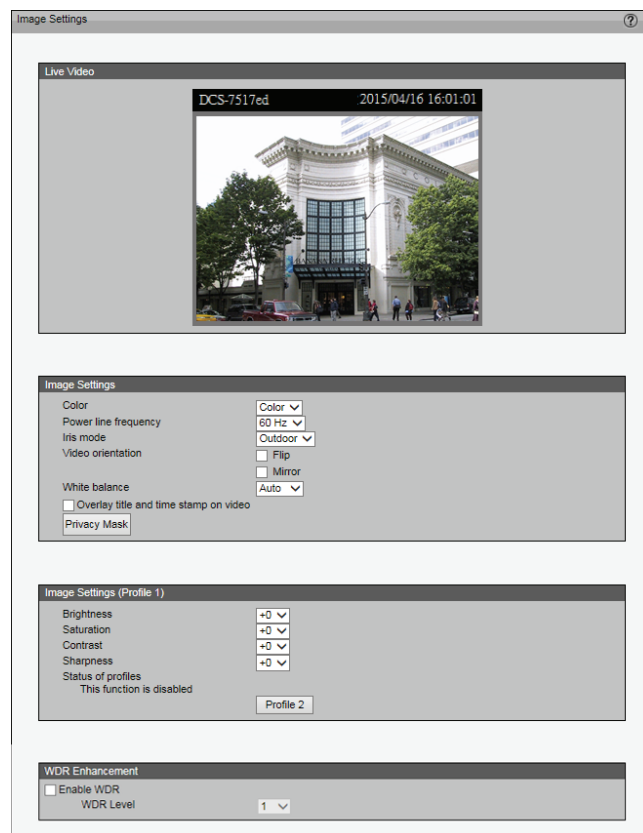

Audio Settings

This page allows you to configure the settings for the built-in audio support.

Mute: Check this box to mute all of the audio capabilities of the camera.

Microphone Input Gain: The microphone sensitivity can be increased or decreased to help provide better audio quality.

AAC bit Rate: Select the desired bit rate for the AAC audio codec.

G711 bit Rate: Select the desired bit rate for the G711 audio codec.



Day and Night Settings

Switch to B/W in Night Mode: Select to automatically enable the camera to switch to black and white when in night mode.

IR Cut Filter: The IR-Cut Removable (ICR) filter mechanically switches between two different sensor filters. It provides the best light conditions both during the day and night. The following options are:

- **Auto Mode:** The camera automatically switches between day and night mode based on the level of ambient light.
- **Day Mode:** In this mode, the camera switches on the IR cut filter at all times, which will block infrared light from reaching the sensor so that colors are not distorted.
- **Night Mode:** The camera switches off the IR cut filter to allow infrared light to pass through. This helps the camera use all available light to see more clearly in low light conditions.
- **Synchronize with Digital Input:** The camera automatically removes the IR cut filter when a DI input is triggered.
- **Schedule Mode:** The camera switches between day and night mode based on a specific schedule. Enter the starting and ending time to use for day mode; during all other times, the camera will use night mode. Note that the time format is [hh:mm] and is expressed in 24-hour time. By default, the starting and ending times for day mode are set to 07:00 and 18:00.

Light Sensor Sensitivity: The light sensor determines when to switch between day mode and night mode when the IR Cut Filter setting is set to Auto Mode. Select Low, Normal, or High sensitivity for the light sensor.

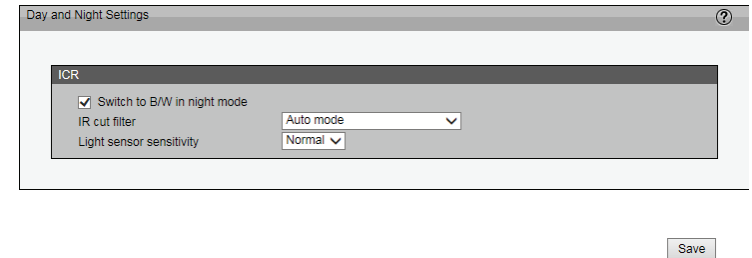

Network

IP Settings

IPv4

LAN: Select this option when the camera is deployed on a local area network (LAN) and is intended to be accessed by local computers. The default setting for the Network Type is LAN. Remember to click **Save** after making any changes.

- **Get IP address automatically (DHCP):** Select this connection if you have a DHCP server such as a router running on your network and would like a dynamic IP address to be assigned to the camera automatically.
- **Use fixed IP address:** You may enter a static or fixed IP address for your camera.

When selected, these options will appear:

IP Address: Enter an IP address.

Subnet Mask: The default value is "255.255.255.0." This helps to determine if the designated IP address is on the same subnet.

Default Router: This is the gateway used to forward frames to destinations in a different subnet. (Invalid router settings will cause a transmission to fail if its destination is in a different subnet).

Primary DNS: The Primary Domain Name Server (DNS) that translates a hostname into an IP address.

Secondary DNS: The Secondary Domain Name Server (DNS) that is used as a backup for the Primary DNS.

Primary WINS Server: The primary WINS server that maintains the database of computer names and IP addresses.

Secondary WINS Server: The secondary WINS server that maintains the database of computer names and IP addresses.

The screenshot shows the 'IP Settings' window with the 'LAN' radio button selected under the 'IPv4' section. The 'Get IP address automatically (DHCP)' radio button is also selected. Other options include 'Use fixed IP address', 'Enable UPnP presentation' (checked), 'Enable UPnP port forwarding' (unchecked), and 'PPPoE' (unselected). The 'IPv6' section has 'Enable IPv6' checked, with buttons for 'IPv6 Information', 'DHCPv6', and 'Manually setup the IP address'. A 'Save' button is at the bottom right.

The screenshot shows the 'IP Settings' window with the 'LAN' radio button selected under the 'IPv4' section. The 'Use fixed IP address' radio button is selected. Below this, a table displays the following values: IP address: 192.168.1.4, Subnet mask: 255.255.255.0, Default router: 192.168.1.2, Primary DNS: 192.168.1.2, and Secondary DNS: 168.95.192.1. Other options include 'Enable UPnP presentation' (checked), 'Enable UPnP port forwarding' (unchecked), and 'PPPoE' (unselected). The 'IPv6' section has 'Enable IPv6' checked, with buttons for 'IPv6 Information', 'DHCPv6', and 'Manually setup the IP address'. A 'Save' button is at the bottom right.

- **Enable UPnP Presentation:** Select this option to enable UPnP presentation for the camera so that when the camera is connected to your network, a shortcut to it will be listed in My Network Places. To utilize this feature, please make sure that UPnP is installed and enabled on your computer.
- **Enable UPnP Port Forwarding:** To access the camera from the Internet, select this option to allow the camera to open ports on the router automatically so that video streams can be sent out from your network. To utilize this feature, make sure that your router supports UPnP and it is activated.

PPPoE: Select this option to configure the camera to connect directly to a PPPoE Internet connection (such as through a DSL modem) and make it accessible from anywhere over the Internet. Note that this feature requires an account provided by your ISP.

Follow the steps below to acquire the camera's public IP address.

1. Set up the camera on your network.
2. Go to **Live View > Setup > Event management > Event settings > Server Settings** (refer to Server Settings to add a new e-mail address or FTP server)
3. Go to **Setup > Event management > Event settings > Media Settings** (please refer to Media Settings). Select System log so that you will receive system logs with the camera's public IP address in your e-mail inbox or on your FTP server.
4. Go to **Setup > Network > IP settings**. Select PPPoE and enter the user name and password provided by your ISP. Click **Save** to enable the setting.
5. The camera will reboot.
6. Disconnect the power to the camera. Remove it from your network and connect it to your DSL modem or PPPoE Internet connection.
7. You can now access your camera through the public IP address, which will be in the system logs sent to your e-mail inbox or FTP server.

The screenshot shows the 'IP Settings' window with the 'IPv4' section selected. Under 'LAN', the following options are visible: 'Get IP address automatically (DHCP)' is selected with a radio button; 'Use fixed IP address' is unselected; 'Enable UPnP presentation' is checked with a checkbox; 'Enable UPnP port forwarding' is unselected; and 'PPPoE' is unselected with a radio button. The 'IPv6' section below has 'Enable IPv6' checked with a checkbox, and 'IPv6 Information', 'DHCPv6', and 'Manually setup the IP address' are all unselected. A 'Save' button is located at the bottom right.

The screenshot shows the 'IP Settings' window with the 'PPPoE' option selected under the 'IPv4' section. The 'User name' and 'Password' fields are empty text boxes, and the 'Confirm password' field is also empty. The 'Status' is displayed as 'None'. The 'IPv6' section below has 'Enable IPv6' checked with a checkbox, and 'IPv6 Information', 'DHCPv6', and 'Manually setup the IP address' are all unselected. A 'Save' button is located at the bottom right.

IPv6

Enable IPv6: Select this option and click **Save** to enable IPv6. Please note that this only works if your network environment and hardware equipment support IPv6. The browser used should be Internet Explorer 8 or Firefox 19 (or above).

When IPv6 is enabled, by default, the camera will listen to router advertisements and will be assigned a link-local IPv6 address accordingly.

IPv6 Information: Click this button to obtain IPv6 information for your camera. If your IPv6 settings work successfully, the IPv6 address list will be listed in the pop-up window.

Please follow the steps below to link to an IPv6 address:

1. Open your web browser.
2. Enter the link-global or link-local IPv6 address in the address bar of your web browser.
3. Press **Enter** on the keyboard or click the **Refresh** button to refresh the webpage.

DHCPv6: Enable this function if you have a DHCPv6 server running on your network and would like a dynamic IPv6 address to be assigned to the camera automatically.

Manually Setup the IP address: Select this option to manually configure your IPv6 settings if your network environment does not have a DHCPv6 server or advertisements-enabled routers.

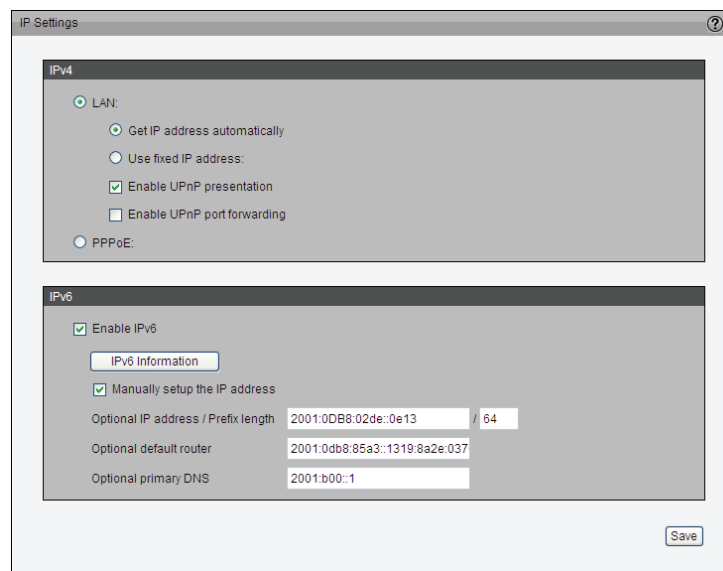
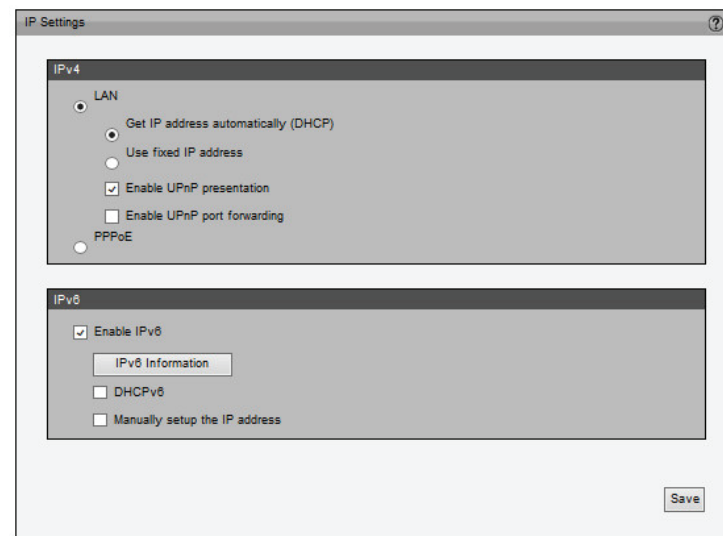

Port and Access Name Settings

HTTPS

By default, the HTTPS port is set to 443. It can also be assigned to another port number between 1025 and 65535.

HTTP

By default, the HTTP port is set to 80 and the secondary HTTP port is set to 8080. They can also be assigned to another port number between 1025 and 65535.

Authentication: Depending on your network security requirements, the camera provides two types of security for an HTTP transaction: basic and digest. If basic authentication is selected, the password is sent in plain text format and carries the potential risk of your traffic being intercepted. If digest authentication is selected, user credentials are encrypted using the MD5 algorithm and thus provide better protection against unauthorized access.

Access name for stream 1 ~ 3: The Network camera supports multiple streams simultaneously. The access name is used to differentiate between streaming sources. You can click **Setup > Video > Video Settings** to set up the video quality of linked streams.

RTSP

To utilize RTSP streaming authentication, make sure that you have set a password for the camera first. Please refer to User Settings for details.

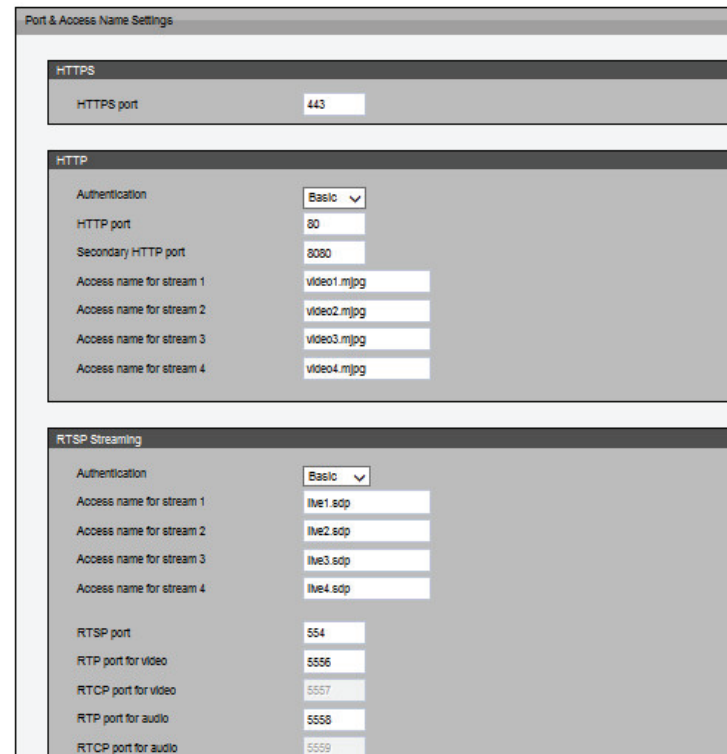

Port & Access Name Settings	
HTTPS	
HTTPS port	443
HTTP	
Authentication	Basic
HTTP port	80
Secondary HTTP port	8080
Access name for stream 1	video1.mjpg
Access name for stream 2	video2.mjpg
Access name for stream 3	video3.mjpg
Access name for stream 4	video4.mjpg
RTSP Streaming	
Authentication	Basic
Access name for stream 1	live1.sdp
Access name for stream 2	live2.sdp
Access name for stream 3	live3.sdp
Access name for stream 4	live4.sdp
RTSP port	554
RTP port for video	5556
RTCP port for video	5557
RTP port for audio	5558
RTCP port for audio	5559

Authentication: Depending on your network security requirements, the camera provides three types of security settings for streaming via RTSP: disable, basic, and digest. If basic authentication is selected, the password is sent in plain text format and carries the potential risk of your traffic being intercepted. If digest authentication is selected, user credentials are encrypted using the MD5 algorithm and thus provide better protection against unauthorized access.

Access Name for Stream 1 ~ 3: This camera can deliver multiple streams simultaneously. The access name is used to differentiate between streaming sources. If you want to use an RTSP player to access the camera, you have to set the video mode to H.264 and use an RTSP URL to request transmission of the stream. For example, "rtsp://[your camera IP]/live1.sdp" would be the RTSP URL for stream 1.

Multicast and Unicast Streaming Protocols

You may choose to enable multicast or unicast for your camera's audio and video streaming so that your camera can establish connections with clients to send and receive content.

RTSP Streaming	
Authentication	Basic
Access name for stream 1	live1.sdp
Access name for stream 2	live2.sdp
Access name for stream 3	live3.sdp
Access name for stream 4	live4.sdp
RTSP port	554
RTP port for video	5556
RTCP port for video	5557
RTP port for audio	5558
RTCP port for audio	5559

Unicast video transmission delivers a stream through point-to-point transmission. Multicast, on the other hand, sends a stream to the multicast group address and allows multiple clients to acquire the stream at the same time by requesting a copy from the multicast group address. As a result, enabling multicast can save network bandwidth.

Multicast Group Address: An IP Multicast group address is used to send and receive content. Sources use this group address as the destination address while sending their data packets. Receivers use this group address to inform the network that they are interested in receiving packets sent to that group.

Multicast Video Port: The ports can be changed to values between 1025 and 65535. The multicast RTP port must be an even number, and the multicast RTCP port number is the multicast RTP port number plus one, and thus is always odd. When the multicast RTP port changes, the multicast RTCP port will change accordingly.

Multicast TTL [1~255]: The multicast TTL (Time To Live) is the value that tells the router the range that a packet can be forwarded.

Click an item to display its detailed configuration information. Select the **Always multicast** option to enable multicast for stream 1 ~ 3.

The screenshot displays the 'Multicast' configuration page. It features four sections, each for a different stream, with a checked checkbox to 'Enable multicast for stream [1-4]'. Each section contains the following fields:

- Multicast group address: 239.128.1.99 (Stream 1), 239.128.1.100 (Stream 2), 239.128.1.101 (Stream 3), 239.128.1.102 (Stream 4)
- Multicast video port: 5560 (Stream 1), 5564 (Stream 2), 5568 (Stream 3), 5572 (Stream 4)
- Multicast RTCP video port: 5561 (Stream 1), 5565 (Stream 2), 5569 (Stream 3), 5573 (Stream 4)
- Multicast TTL [1~255]: 15 (Stream 1), 15 (Stream 2), 15 (Stream 3), 15 (Stream 4)

At the bottom of the page, there are two additional fields:

- Multicast audio port: 5562
- Multicast RTCP audio port: 5563

Dynamic DNS

This section explains how to configure your camera for a dynamic domain name service. DDNS is a service that allows your camera, especially when assigned with a dynamic IP address, to have a fixed host and domain name. With a Dynamic DNS account, the camera automatically updates your IP address with your DDNS server.

Enable DDNS: Select this option to enable DDNS.

Server Name: Select a DDNS server name from the provider drop-down list to fill in the Host Name automatically, or enter your host information.

Host Name: Enter the host name of the DDNS server.

Username: Enter the username or e-mail you use to connect to the DDNS server.

Password: Enter the password you use to connect to the DDNS server.

Status: Displays the current connection status.



The screenshot shows a web interface window titled "Dynamic DNS" with a help icon in the top right corner. Inside the window is a "DDNS Settings" panel. At the top of the panel is a checked checkbox labeled "Enable DDNS". Below it are several fields: "Server name" with a text input containing "www.dlinkddns.com" and a dropdown menu also showing "www.dlinkddns.com"; "Host name" with an empty text input; "User name" with an empty text input; "Password" with an empty text input; "Confirm password" with an empty text input; and "Status" with the text "dis_connected". A "Save" button is located at the bottom right of the window.

HTTPS

This section explains how to enable authentication and encrypted communication over SSL (Secure Socket Layer). It provides security to help protect streaming data transmission over the Internet.

Enable HTTPS

Select to enable HTTPS communication, then select **HTTP & HTTPS** or **HTTPS only** for the connection method. Note that you have to create and install a certificate first in the second column before clicking the **Save** button.

Create and Install Certificate Method

Before using HTTPS for communication with the camera, a certificate must be created.

There are three ways to create and install a certificate:

Create Self-signed Certificate Automatically

1. Select this option.
2. In the first column, select **Enable HTTPS secure connection**, then select a connection option: "HTTP & HTTPS" or "HTTPS only".
3. Click **Save** to generate a certificate.
4. The **Certificate Information** will automatically be displayed in the third column. You can click **Property** to view detailed information about the certificate.
5. Click **Live Video** to return to the main page. Change the address from "http://" to "https://" in the address bar and press Enter. Some Security Alert dialogs will pop up. Click **OK** or **Yes** to enable HTTPS.

Create Self-signed Certificate Manually

1. Click **Create** to open the Create Certificate page, then click **Save** to generate the certificate.
2. The Certificate Information will automatically be displayed in the third column as shown. You can click **Property** to see detailed information about the certificate.

The screenshot shows the HTTPS configuration page with three main sections:

- Enable HTTPS:** A checkbox for "Enable HTTPS secure connection" is checked. Below it are two radio buttons: "HTTP & HTTPS" (selected) and "HTTPS only". A "Save" button is located to the right.
- Create and install certificate method:** Three radio buttons are present: "Create self-signed certificate automatically", "Create self-signed certificate manually" (selected), and "Create certificate request and install". A "Create" button is next to the "Self-signed certificate:" label.
- Certificate Information:** A table-like display showing certificate details:

Status:	Active
Country:	US
State or province:	California
Locality:	Fountain Valley
Organization:	D-Link Corporation
Organization Unit:	Marketing Department
Common Name:	www.dlink.com

Buttons for "Property" and "Remove" are at the bottom.

Create Certificate Request and Install

Select this option to create a certificate from a certificate authority.

1. Click **Create** to open the **Create Certificate** page, then click **Save** to generate the certificate.
2. If you see the information bar, click **OK** and click on the Information bar at the top of the page to allow pop-up.
3. The pop-up window shows an example of a certificate request.
4. Look for a trusted certificate authority that issues digital certificates. Enroll the camera.

Wait for the certificate authority to issue a SSL certificate. Click **Browse...** to search for the issued certificate, then click **Upload** in the second column.

How do I stop using HTTPS for my camera?

1. Deselect **Enable HTTPS secure connection** in the first column and click **Save**. A warning dialog will pop up.
2. Click **OK** to disable HTTPS.
3. You will be redirected to a non-HTTPS page automatically.

If you want to create and install other certificates, please remove the existing one. To remove the signed certificate, deselect **Enable HTTPS secure connection** in the first column and click **Save**, then click **Remove** to erase the certificate.

The screenshot shows the HTTPS configuration interface. It is divided into three sections:

- Enable HTTPS:** A checkbox for "Enable HTTPS secure connection" is checked. Below it are radio buttons for "HTTP & HTTPS" (selected) and "HTTPS only". A "Save" button is located to the right.
- Create and install certificate method:** Radio buttons for "Create self-signed certificate automatically", "Create self-signed certificate manually" (selected), and "Create certificate request and install". A "Create" button is positioned to the right of the "Self-signed certificate:" label.
- Certificate Information:** A form with the following fields:
 - Status: Active (dropdown menu)
 - Country: US
 - State or province: California
 - Locality: Fountain Valley
 - Organization: D-Link Corporation
 - Organization Unit: Marketing Department
 - Common Name: www.dlink.com"Property" and "Remove" buttons are at the bottom.

Access List

This section explains how to control access permissions by verifying the connecting client PC's IP address.

General Settings

Maximum number of concurrent streaming connection(s) limited to: Allows simultaneous live viewing for 1~10 clients (including stream 1 ~ stream 3). The default value is 10. If you modify the value and click **Save**, all current connections will be disconnected and will automatically attempt to reconnect.

View Information: Click this button to display a connection status window that shows a list of the current connections.

- **IP address:** Current connections to the camera.
- **Elapsed time:** How much time the client has been on the webpage.
- **User ID:** If the administrator has set a password for the webpage, clients must enter a user name and password to access the live video. The user name will be displayed in the User ID column. If the administrator allows clients to link to the webpage without a user name and password, the User ID column will be empty.

There are some situations which allow clients access to the live video without a user name and password:

1. The administrator did not set up a user password. For more information about how to set up a user password and manage user accounts, please refer to User Settings.
2. The administrator has set up a user password, but set RTSP Authentication to "disable". For more information about RTSP Authentication, please refer to RTSP Streaming.

- **Refresh:** Click this button to refresh all current connections.
- **Add to deny list:** You can select entries from the Connection Status list and add them to the Deny List to deny access. Please note that the selected connections will only be disconnected temporarily and will automatically try to reconnect. If you want to enable the denied list, please select **Enable access list filtering** and click **Save** in the first column.

Disconnect: If you want to break off the current connections, please select them and click this button. Please note that the selected connections will only be disconnected temporarily and will automatically try to reconnect.

Enable Access List Filtering: Select this item and click **Save** if you want to enable the access list filtering function.

Filter Type

Select **Allow** or **Deny** as the filter type. If you choose **Allow**, only those clients whose IP addresses are on the Access List below can access the camera, and all others will not. On the contrary, if you choose **Deny**, those clients whose IP addresses are on the Access List below will not be allowed to access the camera, and all others will.

Note: If you choose **Allow**, make sure you enter the IP address of the computer you are using to configure your camera before clicking **Save**, or else you may be blocked from accessing the camera.

Filter

You can add a rules to the Access List. Please note that the IPv6 access list column will not be displayed unless you enable IPv6 on the Network page. For more information about IPv6 Settings, please refer to Enable IPv6 for detailed information.

There are three types of rules:

Single: This rule allows you to add an IP address to the Access List.

Network: This rule allows you to assign a network address and corresponding subnet mask to the Access List.

Range: This rule allows you to assign a range of IP addresses to the Access List (IPv4 only).

Administrator IP address

Always allow the IP address to access this device: Select this item and add the Administrator's IP address in this field to make sure the Administrator can always connect to the device.

ACCESS List

General Settings

Maximum number of concurrent streaming connection(s) limited to: 10 [View Information](#)

Enable access list filtering

Filter Type

Allow Deny

Filter

IPv4 access list

192.168.0.99

[Add](#) [Delete](#)

Administrator IP address

Always allow the IP address to access this device 192.168.0.200

IP address	Elapsed time	User ID
Refresh	Add to deny list	Disconnect

Advanced Settings

SNMP configuration

This section explains how to use SNMP on the network camera. The Simple Network Management Protocol is an application layer protocol that facilitates the exchange of management information between network devices. It helps network administrators to remotely manage network devices, and to find and solve network problems with ease.

SNMP consists of the following three key components:

1. **Manager:** Network-Management Station (NMS), a server which executes applications that monitor and control managed devices.
2. **Agent:** A network-management software module on a managed device which transfers the status of managed devices to the NMS.
3. **Managed device:** A network node on a managed network. For example: routers, switches, bridges, hubs, computer hosts, printers, IP telephones, network cameras, web server, and database.

Before configuring SNMP settings on this page, please enable your NMS first.

Enable SNMPv1, SNMPv2c: Select this option and enter the names of the Read/Write community and Read Only community according to your NMS settings.

Enable SNMPv3: This option enables cryptographic security, which allows you to set an Authentication password and Encryption password for stronger security.

- **Security name:** Enter the community name according to your NMS settings.
- **Authentication type:** Select MD5 or SHA as the authentication method.
- **Authentication password:** Enter the password for authentication (at least 8 characters).
- **Encryption password:** Enter a password for encryption (at least 8 characters).

The screenshot displays the 'Advanced Settings' web interface. It is divided into several sections:

- SNMP Configuration:**
 - Enable SNMPv1, SNMPv2c
 - Read / Write community: write
 - Read only community: public
 - Enable SNMPv3
 - Read / Write Security name: write
 - Authentication type: MD5
 - Authentication password: [input field]
 - Encryption password: [input field]
 - Read only security name: public
 - Authentication type: MD5
 - Authentication password: [input field]
 - Encryption password: [input field]
- IEEE 802.1x:**
 - Enable IEEE 802.1x
 - EAP method: EAP-TLS
 - Identity: [input field]
 - Private key password: [input field]
 - CA certificate: [input field] Browse... Upload
 - Status: no file Remove
 - Client certificate: [input field] Browse... Upload
 - Status: no file Remove
 - Client private key: [input field] Browse... Upload
 - Status: no file Remove
- CoS:**
 - Enable CoS
 - VLAN ID: 4095
 - Live Video: 0
 - Event / Alarm: 0
 - Management: 0
- QoS / DSCP:**
 - Enable QoS / DSCP
 - Live Video: 0
 - Event / Alarm: 0
 - Management: 0

Each section has a 'Save' button at the bottom right.

IEEE 802.1x

Enable this function if your network environment uses IEEE 802.1x, which is a port-based network access control. The network devices, any intermediary switch/access point/hub, and RADIUS server must support 802.1x and have it enabled.

The 802.1x standard is designed to enhance the security of local area networks, which provides authentication to network devices (clients) attached to a network port (wired or wireless). If all certificates between client and server are verified, a point-to-point connection will be enabled. If authentication fails, access on that port will be prohibited. 802.1x utilizes an existing protocol, the Extensible Authentication Protocol (EAP), to facilitate communication.

Please follow the steps below to enable 802.1x:

1. Before connecting the camera to a protected network with 802.1x, apply for a digital certificate from a Certificate Authority (i.e., MIS of your company) that can be validated by a RADIUS server.
2. Connect the camera to a PC or notebook outside of your protected LAN. Open the configuration page of the camera. Select EAP-PEAP or EAP-TLS as the EAP method. In the following fields, enter the ID and password issued by the CA, then upload the related certificate(s).
3. When all the settings are complete, move the camera to the protected LAN by connecting it to an 802.1x enabled switch. The devices will then start the authentication automatically.

The screenshot displays the 'Advanced Settings' interface of a camera, divided into several configuration sections:

- SNMP Configuration:** Includes checkboxes for 'Enable SNMPv1, SNMPv2c' and 'Enable SNMPv3'. It features input fields for 'Read / Write community' (set to 'write') and 'Read only community' (set to 'public'). For both versions, it includes fields for 'Read / Write Security name' (set to 'write'), 'Authentication type' (set to 'MD5'), 'Authentication password', and 'Encryption password'. A 'Save' button is located at the bottom right of this section.
- IEEE 802.1x:** Features a checked 'Enable IEEE 802.1x' checkbox. The 'EAP method' is set to 'EAP-TLS'. It includes fields for 'Identity' and 'Private key password'. There are three rows for certificates: 'CA certificate', 'Client certificate', and 'Client private key'. Each row has a 'Remove' button, a 'Browse...' button, and an 'Upload' button. A 'Save' button is at the bottom right.
- CoS:** Includes a checked 'Enable CoS' checkbox. The 'VLAN ID' is set to '4095'. It has dropdown menus for 'Live Video', 'Event / Alarm', and 'Management', all set to '0'.
- QoS / DSCP:** Includes a checked 'Enable QoS / DSCP' checkbox. It has input fields for 'Live Video', 'Event / Alarm', and 'Management', all set to '0'. A 'Save' button is at the bottom right.

QoS (Quality of Service)

Quality of Service refers to a resource reservation control mechanism, which guarantees a certain quality of transmission to different services on the network. Quality of service guarantees are important if the network capacity is insufficient, especially for real-time streaming multimedia applications. It gives you the ability to prioritize traffic and guarantee a certain level of performance. It can also help you control the amount of bandwidth each application may use, and thus provide higher reliability and stability for your network.

Requirements for QoS:

To utilize QoS in a network environment, the following requirements must be met:

- All network switches and routers in the network must include support for QoS.
- The network video devices used in the network must have QoS enabled.

CoS

IEEE802.1p defines a QoS model at OSI Layer 2 (Data Link Layer), which is called CoS, Class of Service. It adds a 3-bit value to the VLAN MAC header, which indicates prioritization from 0~7 (eight different classes of service are available). The priority is set up on the network switches, which then use different queuing disciplines to forward the packets.

Please follow the steps below to enable CoS:

1. Click **Enable CoS**.
2. Enter the VLAN ID of your switch (0~4095).
3. Choose the priority for each application (0~7). Higher values will provide higher priority.

Note:

- A VLAN Switch (802.1p) is required. Web browsing may fail if the CoS settings are incorrect.
- Class of Service technologies do not guarantee a level of service in terms of bandwidth and delivery time. They only offer a "best-effort." You can think of CoS as "coarsely-grained" traffic control and QoS as "finely-grained" traffic control.
- Though CoS is simple to manage, it lacks scalability and does not offer end-to-end guarantees since it is based on L2 protocol.

The screenshot displays the 'Advanced Settings' configuration page, divided into four sections:

- SNMP Configuration:** Includes checkboxes for 'Enable SNMPv1, SNMPv2c' and 'Enable SNMPv3'. Fields for 'Read / Write community', 'Read only community', 'Read / Write Security name', 'Authentication type' (MD5), 'Authentication password', and 'Encryption password' are present for both versions.
- IEEE 802.1x:** Features a checked 'Enable IEEE 802.1x' option. It includes a dropdown for 'EAP method' (EAP-TLS), and fields for 'Identity', 'Private key password', 'CA certificate', 'Client certificate', and 'Client private key', each with a 'Browse...' button and an 'Upload' button. 'Status' indicators show 'no file' for each certificate field.
- CoS:** Shows 'Enable CoS' checked. The 'VLAN ID' is set to 4095. Priority dropdowns for 'Live Video', 'Event / Alarm', and 'Management' are all set to 0.
- QoS / DSCP:** Shows 'Enable QoS / DSCP' checked. Priority dropdowns for 'Live Video', 'Event / Alarm', and 'Management' are all set to 0.

'Save' buttons are located at the bottom right of the SNMP and CoS sections.

QoS/DSCP

DSCP-ECN defines QoS at Layer 3 (Network Layer). The Differentiated Services (DiffServ) model is based on packet marking and router queuing disciplines. The marking is done by adding a field to the IP header, called the DSCP (Differentiated Services Code Point). This is a 6-bit field that provides 64 different class IDs. It gives an indication of how a given packet is to be forwarded, known as the Per Hop Behavior (PHB). The PHB describes a particular service level in terms of bandwidth, queuing theory, and dropping (discarding the packet) decisions. Routers at each network node classify packets according to their DSCP value and give them a particular forwarding treatment. For example, how much bandwidth should be reserved.

Please follow the steps below to enable QoS/DSCP:

1. Click **Enable QoS/DSCP**.
2. Choose the priority for each application. Lower values will provide higher priority, starting with 1.

The screenshot displays the 'Advanced Settings' configuration page, which is divided into several sections:

- SNMP Configuration:** This section is expanded and shows two sub-sections. The first sub-section is for SNMPv1 and SNMPv2c, with 'Enable SNMPv1, SNMPv2c' checked, 'Read / Write community' set to 'write', and 'Read only community' set to 'public'. The second sub-section is for SNMPv3, with 'Enable SNMPv3' checked, 'Read / Write Security name' set to 'write', 'Authentication type' set to 'MD5', and 'Read only security name' set to 'public'. Both sub-sections have empty fields for 'Authentication password' and 'Encryption password'. A 'Save' button is located at the bottom right of this section.
- IEEE 802.1x:** This section is expanded and shows 'Enable IEEE 802.1x' checked. The 'EAP method' is set to 'EAP-TLS'. There are empty fields for 'Identity' and 'Private key password'. The 'CA certificate' section includes a 'Remove' button and 'Browse...' and 'Upload' buttons. The 'Client certificate' and 'Client private key' sections also include 'Remove', 'Browse...', and 'Upload' buttons. The status for each certificate is 'no file'.
- CoS:** This section is expanded and shows 'Enable CoS' checked. The 'VLAN ID' is set to '4095'. The 'Live Video', 'Event / Alarm', and 'Management' priorities are all set to '0'.
- QoS / DSCP:** This section is expanded and shows 'Enable QoS / DSCP' checked. The 'Live Video', 'Event / Alarm', and 'Management' priorities are all set to '0'.

A 'Save' button is located at the bottom right of the entire configuration page.

Event Management

Motion Detection

Motion can be detected by measuring change in speed or vector of an object or objects in the field of view.

Enable Motion Detection: Select this option to turn on the motion detection feature.

Window Name: Create a name for the selected motion window. It will appear at the top of the motion window.

Sensitivity: Set how sensitive motion detection will be from 0% to 100%. A low sensitivity means that there must be large changes between two images in order to detect motion, and a high sensitivity means that even small changes will cause motion to be detected.

Low sensitivities may be useful when monitoring an area that has flickering lights or a window to the outside in view. High sensitivities may be useful when monitoring an area that rarely changes, such as a storeroom or warehouse.

Percentage: Set how much of the area being monitored for motion must change for motion to be detected. A low percentage means that only part of the area being monitored has to change to detect motion, and a high percentage means that most of the area needs to change to detect motion.

Low percentages can be useful when monitoring an area such as a large room, and high percentages can be useful when you are only monitoring a specific part of the camera's view, such as a doorway.

Note: Setting a higher sensitivity and a lower percentage will make motion easier to be detected.

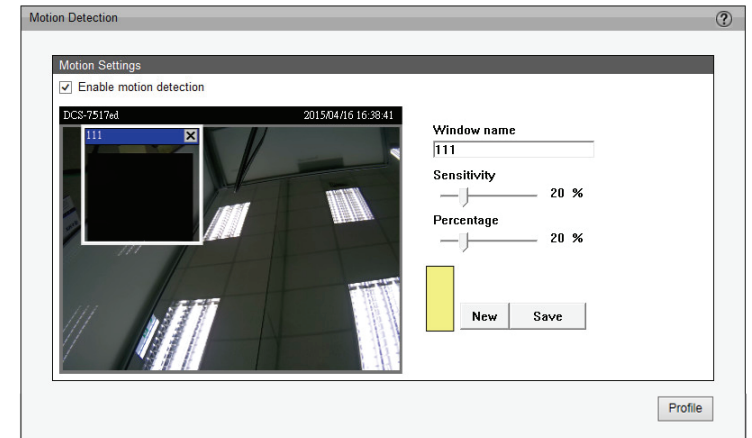

Configuration

New: Click to add a new window to specify an area of the video to monitor for motion. A maximum of three motion windows can be opened simultaneously. Use your mouse to drag the window frame to resize or the title bar to move. Clicking on the 'x' at the upper right corner of the window will close the window.

Profile: You can configure three sets of sensor settings: Day, Night, and Schedule.

Save: Save the configured settings.

To enable motion detection, follow the steps below:

1. Click **New** to add a new motion detection window.
2. Enter a name in the **Window Name** field.
3. Set the **Sensitivity** and **Percentage** settings to adjust how the camera will detect motion.
4. Click **Save** to apply the changes.
5. Select **Enable motion detection** to activate motion detection.

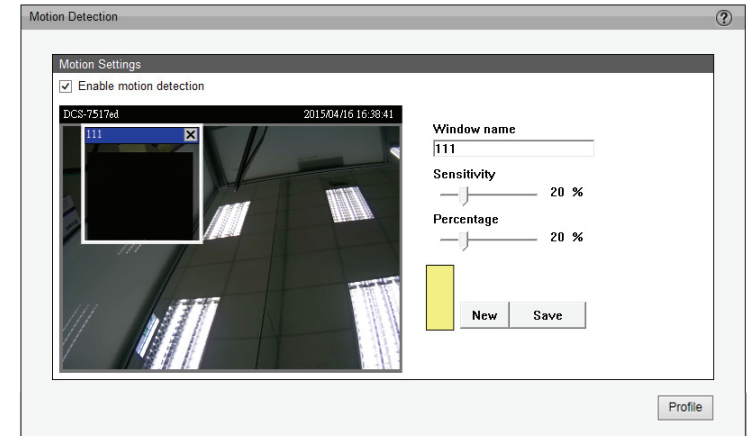

Tamper Detection

With tamper detection, the camera is capable of detecting incidents such as when the camera is redirected, blocked, de-focused, or even spray painted.

To enable tamper detection, follow the steps given below:

1. Select **Enable camera tampering detection**.
2. Enter the tamper trigger duration (10 sec. ~ 10 min.). The tamper alarm will be triggered only when the tampering factor (the difference between the current frame and pre-saved background) exceeds the trigger threshold.

You can configure what the camera will do when tampering is detected on the Event Settings page and selecting **Camera Tampering Detection** as the source in Event Settings > Event Settings. Please refer to "Event Settings" on page 58 for more detailed information.

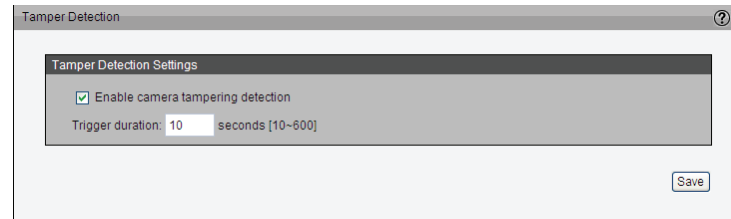

DI and DO

This camera has a general I/O terminal block with one digital input and digital output for device control. The I/O connector provides the physical interface for digital input (DI+, GND) and digital output (DO+, GND) that is used for connecting a variety of external alarm devices to the camera such as IR-Sensors and alarm relays.

You can configure what the camera will do when a DI signal is detected, or you can configure when the camera will send a DO signal on the Event Settings page. Please refer to "Event Settings" on page 58 for more detailed information.

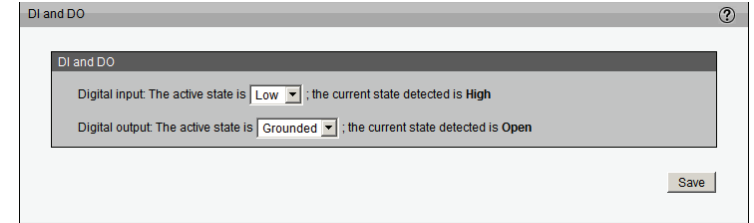

DI/DO Specifications

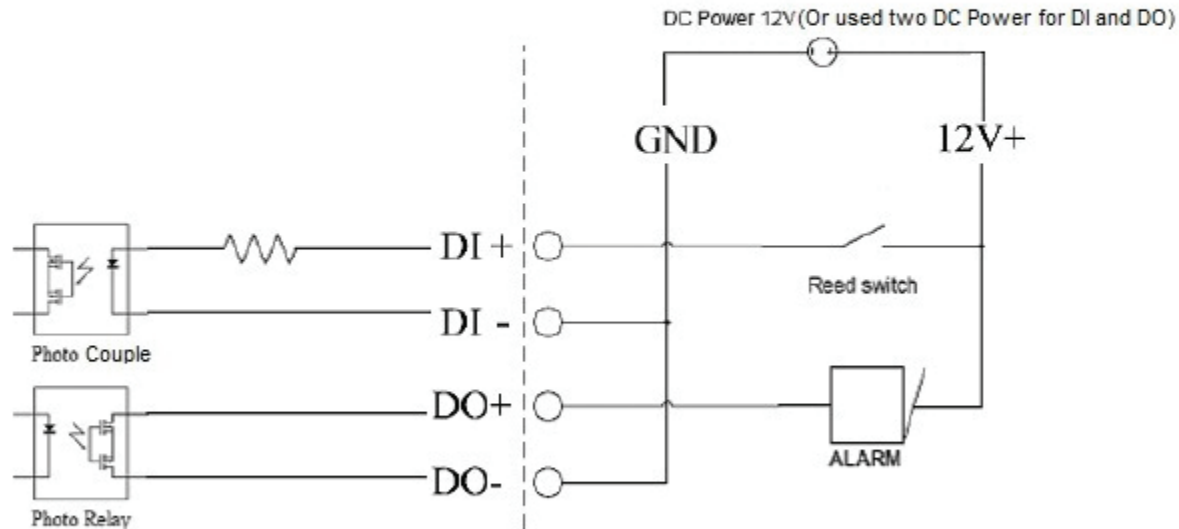

Event Settings

This section explains how to configure the camera to respond to particular situations (event). One example is configuring the camera to send images to an FTP server or e-mail address when motion is detected.

Server Settings

Click **Add** on Event Settings page to open the Server Setting page. On this page, you can configure up to five servers to save snapshots, video, or system logs to.

Server name: Enter a name for the server.

- **Server Type:** There are four choices of server types available: E-mail, FTP, HTTP, and Network storage. Select an item to display detailed configuration options. You can configure either one or all of them.

E-mail: Select this to send the media files via e-mail when a trigger is activated.

- **Sender e-mail address:** Enter the e-mail address of the sender.
- **Recipient e-mail address:** Enter the e-mail address of the recipient.
- **Server address:** Enter the domain name or IP address of the e-mail server.
- **User name:** Enter the user name of the e-mail account if necessary.
- **Password:** Enter the password of the e-mail account if necessary.
- **Server port:** The default mail server port is set to 25. You can also manually set another port.

If your SMTP server requires a secure connection (SSL), select **This server requires a secure connection (SSL)**.

To verify if the e-mail settings are correctly configured, click **Test**. The result will be shown in a pop-up window. If successful, you will also receive an e-mail indicating the result.

Click **Save** to enable the settings, then click **Close** to exit the page.

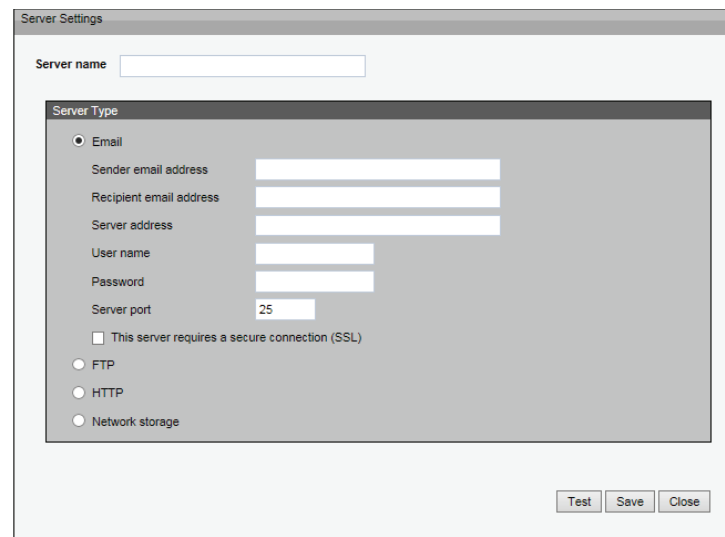
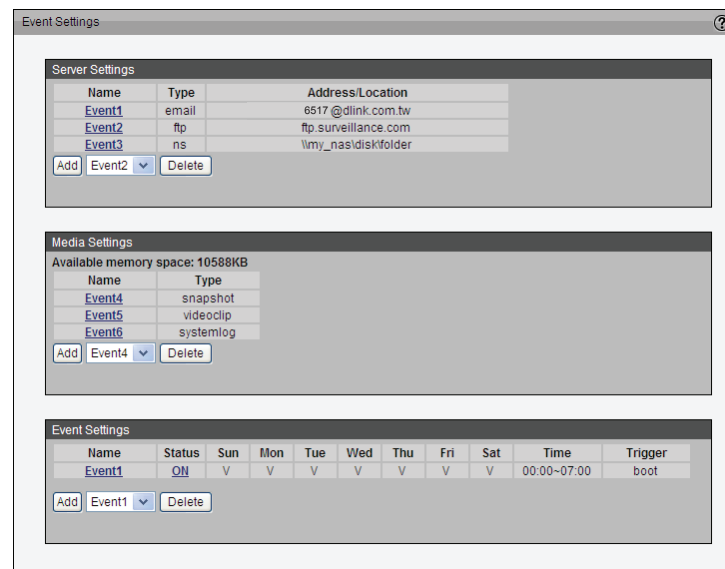

FTP: Select this to send the media files to an FTP server when a trigger is activated.

- **Server address:** Enter the domain name or IP address of the FTP server.
- **Server port:** By default, the FTP server port is set to 21. It can also be assigned to another port number between 1025 and 65535.
- **User name:** Enter the login name of the FTP account.
- **Password:** Enter the password of the FTP account.
- **FTP folder name:** Enter the folder where the media file will be placed. If the folder name does not exist, the camera will create one on the FTP server.
- **Passive mode:** Most firewalls do not accept new connections initiated from external requests. If the FTP server supports passive mode, select this option to enable passive mode FTP and allow data transmission to pass through the firewall.

To verify if the FTP settings are correctly configured, click **Test**. The result will be shown in a pop-up window as shown. If successful, you will also receive a test.txt file on the FTP server.

Click **Save** to enable the settings, then click **Close** to exit the page.

HTTP: Select this to send the media files to an HTTP server when a trigger is activated.

- **URL:** Enter the URL of the HTTP server.
- **User name:** Enter the user name if necessary.
- **Password:** Enter the password if necessary.

To verify if the HTTP settings are correctly configured, click **Test**. The result will be shown in a pop-up window as below. If successful, you will receive a test.txt file on the HTTP server. Click **Save** to enable the settings then click **Close** to exit the page.

Network storage: Select this to send the media files to a network storage location when a trigger is activated. Click **Save** to enable the setting, then click **Close** to exit the page. When completed, the new server settings will automatically be displayed on the Event Settings page.

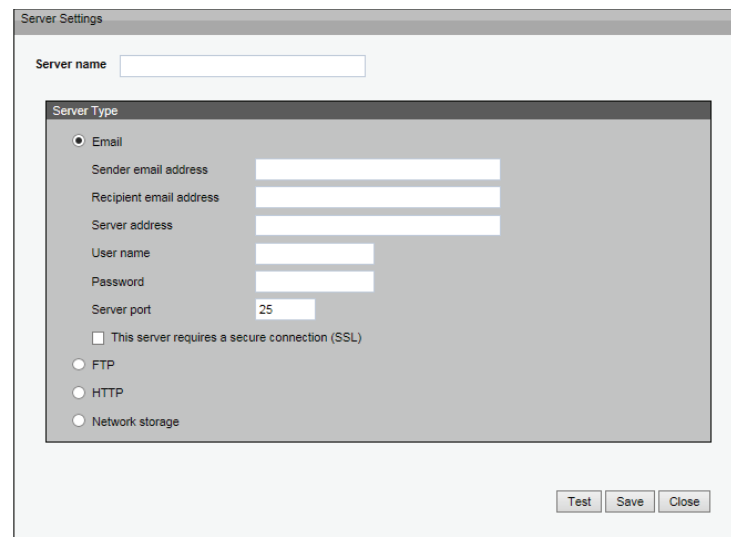
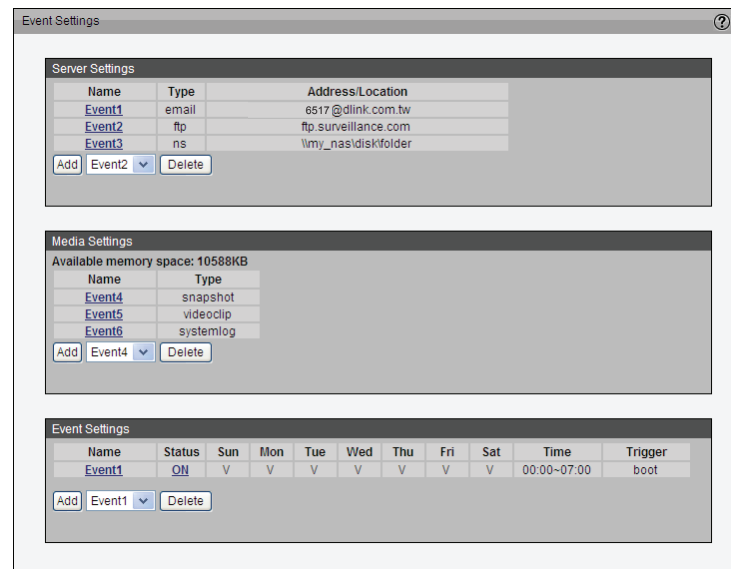

Configuration

Media Settings

Click **Add** to open the Media Settings page. On this page, you can specify up to five types of media that can be sent when a trigger is activated.

Media name: Enter a name for the media setting.

Media Type: There are three media types available: Snapshot, Video Clip, and System log. Select an item to display detailed configuration options. You can configure either one or all of them.

Snapshot: Select this to send snapshots when a trigger is activated.

Source: Select this to take snapshots from stream 1 ~ 3.

Send pre-event images: Set the number of pre-event images to take. Pre-event images are images taken before the trigger is activated. You can set up to seven pre-event images to be taken.

Send post-event images: Set the number of post-event images to take. Post-event images are images taken after a trigger is activated. You can set up to seven post-event images to be taken.

File name prefix: Enter the text that will be appended to the beginning of the file name.

Add date and time suffix to the file name: Select this option to add a date/time suffix to the file name.

Click **Save** to enable the settings, then click **Close** to exit the page.

The screenshot shows the 'Event Settings' page with three main sections:

- Server Settings:** A table with columns 'Name', 'Type', and 'Address/Location'. It lists three events: Event1 (email), Event2 (ftp), and Event3 (ns). Below the table are 'Add', 'Event2' (dropdown), and 'Delete' buttons.
- Media Settings:** Shows 'Available memory space: 10588KB'. It has a table with columns 'Name' and 'Type' listing Event4 (snapshot), Event5 (videoclip), and Event6 (systemlog). Below are 'Add', 'Event4' (dropdown), and 'Delete' buttons.
- Event Settings:** A table with columns 'Name', 'Status', 'Sun', 'Mon', 'Tue', 'Wed', 'Thu', 'Fri', 'Sat', 'Time', and 'Trigger'. It lists Event1 with status 'ON' and trigger 'boot'. Below are 'Add', 'Event1' (dropdown), and 'Delete' buttons.

The screenshot shows the 'Media Settings' page with the following elements:

- Media name:** A text input field.
- Media Type:** A section with three radio button options: 'Snapshot', 'Video clip', and 'System log'. The 'System log' option is selected.
- Buttons:** 'Save' and 'Close' buttons at the bottom right.

Video clip: Select this to send video clips when a trigger is activated.

Source: Select a source for the video clip.

Pre-event recording: This sets how many seconds to record before the trigger is activated. You can record up to nine seconds of pre-event video.

Maximum duration: This sets how many seconds of video to record in total, and can be set up to 20 seconds. For example, if pre-event recording is set to 5 seconds and the maximum duration is set to 10 seconds, the camera will continue to record for another 5 seconds after the trigger is activated.

Maximum file size: Specify the maximum file size allowed.

File name prefix: Enter the text that will be appended to the beginning of the file name.

Click **Save** to enable the settings, then click **Close** to exit the page.

System log: Select this to send a system log when a trigger is activated. Click **Save** to enable the settings, then click **Close** to exit the page.

When you are done, click **Save** to enable the settings and click **Close** to exit this page. The new media settings will appear on the Event Settings page.

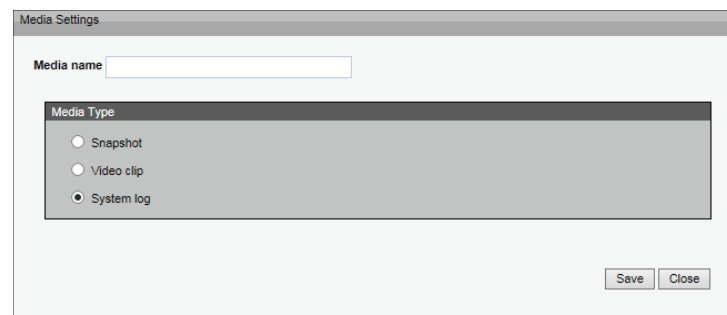
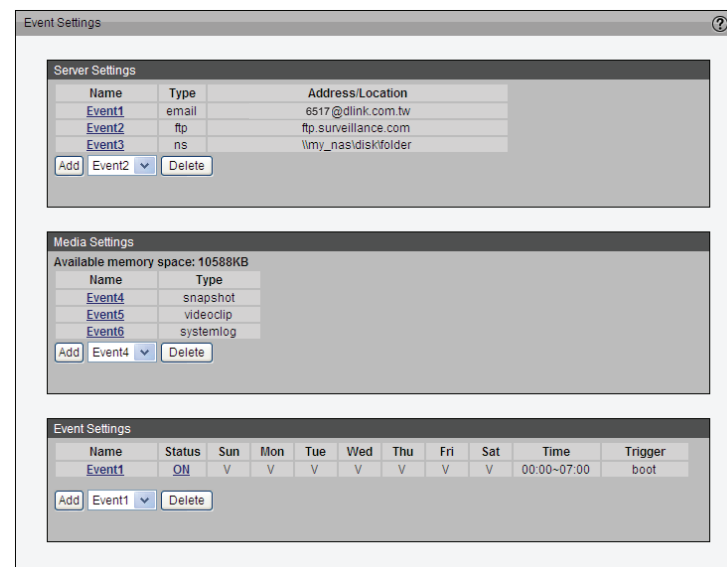

Event Settings

In the Event Settings column, click **Add** to open the Event Settings page. On this page, you can configure an event by setting a Trigger, Schedule, and Action. A total of 3 events can be configured.

Event name: Enter a name for the event.

Enable this event: Select this to activate this event.

Priority: Set the priority for this event (High, Normal, or Low). Events with higher priority will be executed first.

Detect next event after * seconds: Select the delay time before allowing another event to be triggered. This is used for both motion detection events and digital input events.

Trigger

Here, you can define what will trigger the event. There are several methods to trigger an event, as shown below. Select an item to display detailed configuration options.

Video motion detection: This option makes use of the built-in motion detection mechanism as a trigger source. To enable this function, you need to configure a Motion Detection Window first. For more information, please refer to "Motion Detection" on page 54 for details.

Periodically: This option allows the camera to trigger periodically according to the duration you set. You can set the duration up to 10 minutes.

Digital input: This option allows the camera to use an external digital input device or sensor as a trigger source. Depending on your application, there are many choices of digital input devices on the market, such as devices that detect changes in temperature, vibration, sound, light, etc.

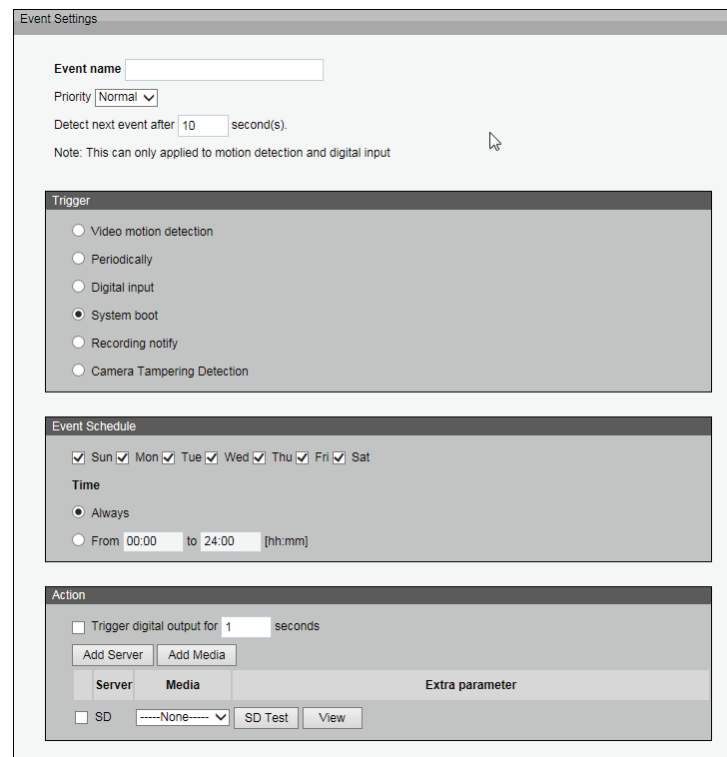
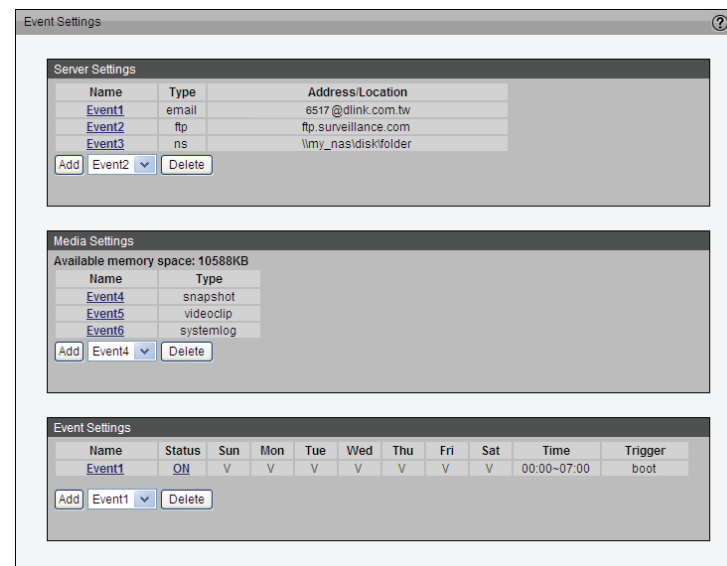

System boot: This option triggers the camera when the camera boots up, such as when power is restored to the camera after a power outage.

Recording notify: This option allows the camera to trigger an event when the recording disk is full or when recording starts to rewrite older data.

Camera tampering detection: This option allows the camera to trigger an event when the camera detects that it is being tampered with. To enable this function, you need to configure the Tamper detection option first. Please refer to "Tamper Detection" on page 56 for more detailed information.

Event Schedule

Here, you can specify the period of time when the event can be run.

1. Select the day(s) of the week.
2. Select the recording schedule in 24-hr time format.

Action

Here, you can define the actions to be performed by the camera when the event trigger is activated.

Trigger digital output for X seconds: Enter the number of seconds to trigger the digital output for when an event happens.

To record video or snapshots for your action, you will need to add a server and media type first.

- **Add Server:** Refer to Server Settings for more information.
- **Add Media:** Refer to Media Settings for more information.
- **SD:** Select the microSD card as the location for files to be sent to. Click **SD Test** to verify that the microSD card is working properly. Click **View** to open the microSD card to view files.
- **Email:** From the drop down menu, select the e-mail address to send notifications to.

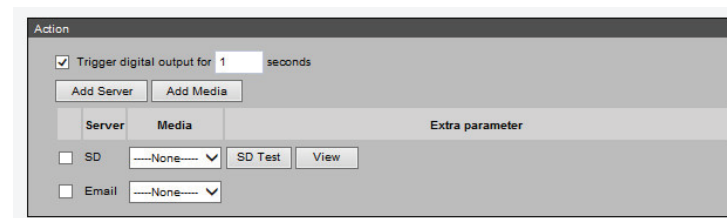
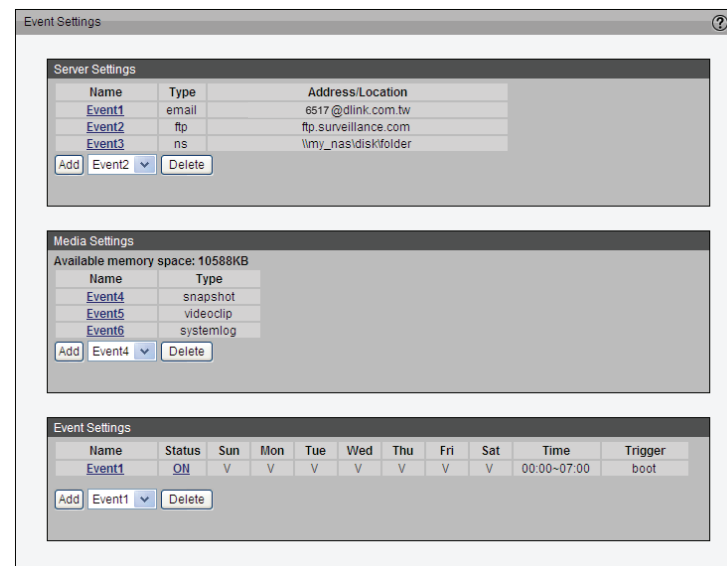

Recording

Recording Settings

Click **Add** to open the recording settings page. On this page, you can define when and how the camera will record video based on a schedule or when it is disconnected from the network. A total of two recording settings can be configured.

Recording name: Enter a name for the recording setting.

Enable this recording: Select this option to enable the recording you are specifying.

Priority: Select the relative importance of this recording setting (High, Normal, and Low).

Source: Select the recording source (stream 1 ~ 3).

Trigger: Select a trigger source.

Schedule: Selecting this will record video according to the schedule you specify.

Network Fail: Selecting this will record video when a network failure is detected.

Recording Schedule: Specify period of time this recording will be active.

1. Select the days of the week.
2. Select the recording start and end times in 24-hr time format.

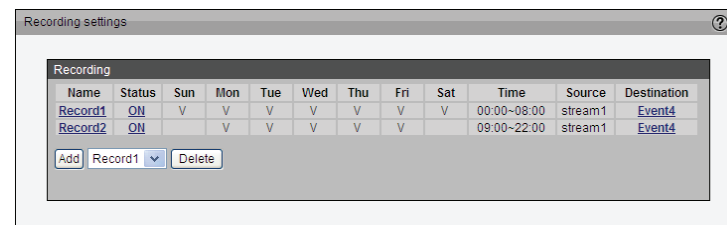

Name	Status	Sun	Mon	Tue	Wed	Thu	Fri	Sat	Time	Source	Destination
Record1	ON	V	V	V	V	V	V	V	00:00-08:00	stream1	Event4
Record2	ON		V	V	V	V	V		09:00-22:00	stream1	Event4

Buttons: Add, Record1 (dropdown), Delete

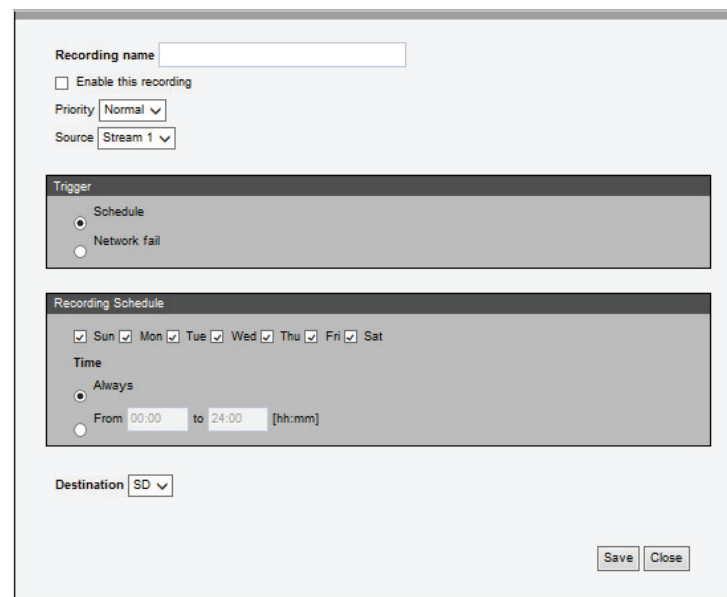

Recording name:

Enable this recording

Priority: Normal (dropdown)

Source: Stream 1 (dropdown)

Trigger:

Schedule

Network fail

Recording Schedule:

Sun Mon Tue Wed Thu Fri Sat

Time:

Always

From 00:00 to 24:00 [hh:mm]

Destination: SD (dropdown)

Buttons: Save, Close

Destination: You can choose to record to network storage or a microSD card.

When you are done, select **Enable this recording**. Click **Save** to enable the setting and click **Close** to exit this page. The new recording will appear in the drop-down list on the recording page.

To remove a recording setting from the list, select a recording name from the drop-down list and click **Delete**.

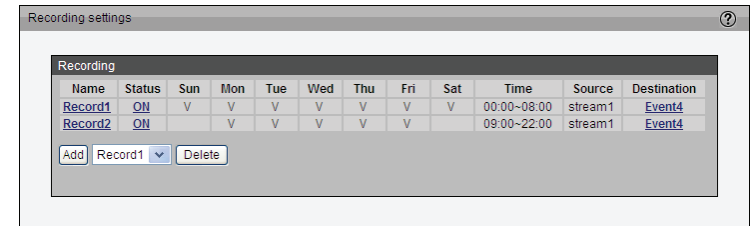

Recording settings

Name	Status	Sun	Mon	Tue	Wed	Thu	Fri	Sat	Time	Source	Destination
Record1	ON	V	V	V	V	V	V	V	00:00-08:00	stream1	Event4
Record2	ON		V	V	V	V	V		09:00-22:00	stream1	Event4

Add Record1 Delete

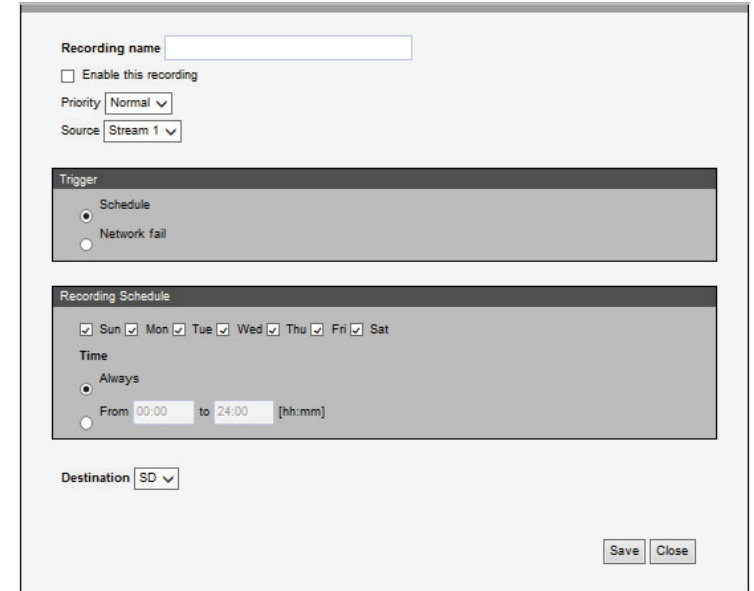

Recording name

Enable this recording

Priority

Source

Trigger

Schedule

Network fail

Recording Schedule

Sun Mon Tue Wed Thu Fri Sat

Time

Always

From to [hh:mm]

Destination

Save Close

Local Storage

Click on the dropdown icon to expand or collapse the menu items in this section.

SD Card Management

SD Card Status: This shows the status and reserved space of your microSD card.

Please remember to format the microSD card when using for the first time.

Format: Click this icon to automatically format the microSD card

Enable Cyclic Storage: If you select this item, when the maximum capacity you specify is reached, the oldest files will be overwritten by newer ones. The reserved amount is reserved for cyclic recording to prevent malfunction. This value must be larger than 15 Mbytes.

Enable Automatic Disk Cleanup: Check this item and enter the number of days you wish to retain a file. For example, if you enter "7 days", the recorded files will be stored on the microSD card for 7 days.

Click **Save** to enable your settings.

Searching and Viewing the Records

File Attributes: Select one or more items as your search criteria.

Trigger Type: Select the type of trigger that was used to create the recording.

Media Type: Select the type of media that was used to save the recording.

Trigger Time: Manually enter the time range you want to search. Click **Search** and the recorded data corresponding to the search criteria will be listed in Search Results Window.

From/To: Enter the dates to search from and to.

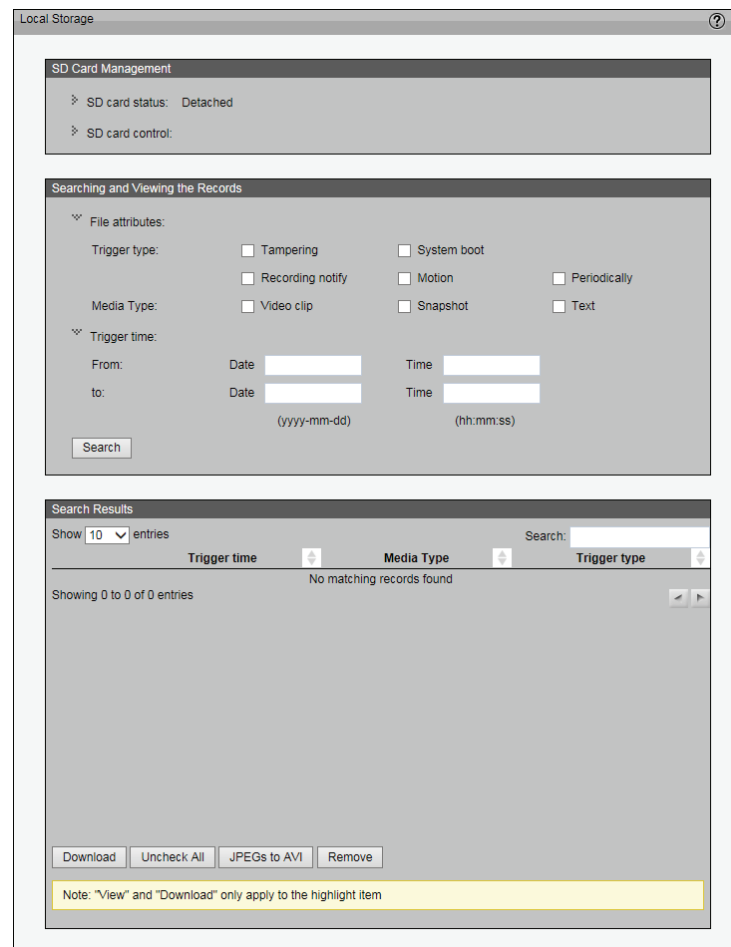

Search Results

Show Entries: Select the number of search results to display at a time.

Search: Enter a keyword to search through the displayed results.

Download: Select a line from the search results and click this button to download the file to your computer.

Uncheck All: Click this button to uncheck all of the displayed search results.

JPEGs to AVI: Select multiple JPEGs and click this button to convert them into a single AVI video which can be saved to your local computer.

Remove: Select a search result and click this button to remove the file completely.

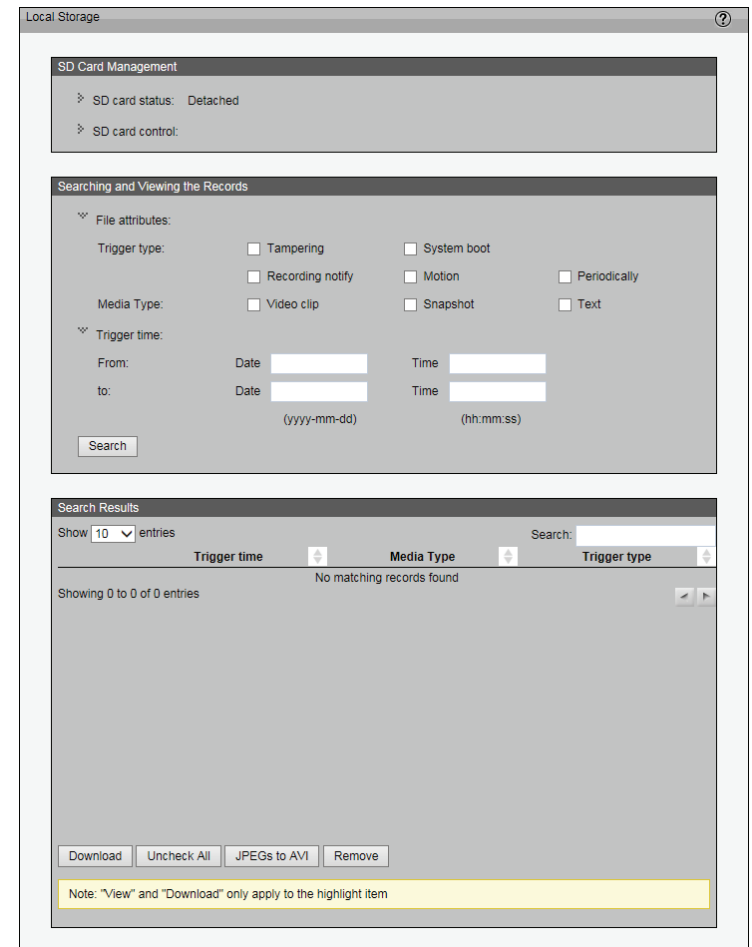

PTZ Control

Digital PTZ

You can save a total of 20 preset positions and select a set of preset positions for the camera to patrol.

Please follow the steps below to save a position as a preset:

1. Adjust the camera view to your desired position using the buttons on the right side of the window.
2. Enter a name for the preset position, which can be up to 40 characters long. Click **Add** to enable the Setting. The new preset position will be displayed in the Preset Location list on the left-hand side.
3. To add additional preset positions, please repeat steps 1~2.
4. To remove a preset position from the list, select it from the drop-down list and click **Delete**.
5. Click **Save** to enable the setting. Your preset positions will also be displayed on the Live Video page. Select one from the drop-down list and the camera will move to the selected preset position.

Patrol Settings

You can select a sequence of preset positions for the camera to patrol. Please follow the steps below to set up a patrol schedule:

1. Click a preset location on the list and click **Select**.
2. The selected preset position will be displayed in the Source list.
3. Set the Dwelling time for the preset position during auto patrol; this determines how long the camera will stay at that preset position. Enter a value and click **Update**.
4. Repeat step 1 and 3 to add additional preset position to the patrol list.
5. If you want to remove a preset position from the patrol list, select it from the Source list and click **Remove**.
6. Select a position and click **Up** or **Down** to rearrange the patrol order.
7. Click **Save** to enable the setting.

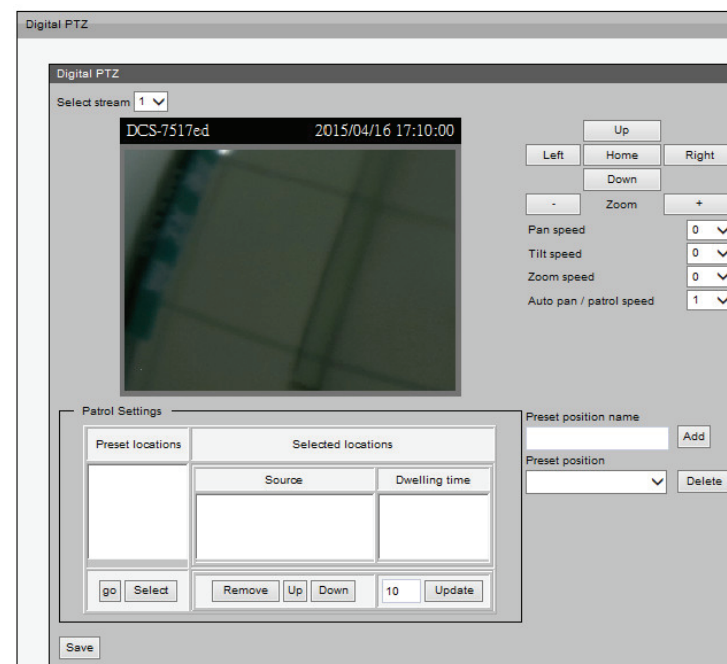



Lens Control

The settings on this page allow you to remotely fine tune the zoom and focus to achieve optimal performance.

Lens Zoom Speed: You can adjust the speed of the zoom by selecting a number from the drop-down menu. Selecting a higher number will result in a faster zoom.

  Use this slider control to fine tune the camera zoom.

  Use this slider control to fine tune the camera focus.

Auto Focus: Allow the camera to adjust the focus automatically.

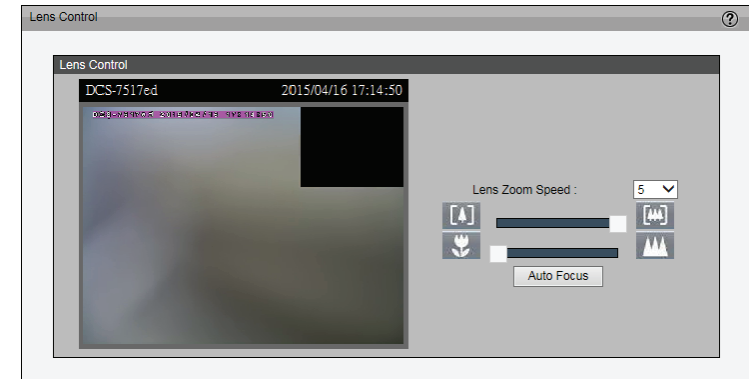

System

User Settings

This section explains how to enable password protection and create multiple accounts.

Admin Password Setup:

The administrator account name is “admin”, which is permanent and cannot be changed. The default password is blank. You can change the password by typing it into the **Password** and **Confirm password** boxes and clicking **Save**.

Add User Account

This section lets you add a new user account and set privileges for it.

Username: Enter a username for the new account.

Password: Enter a password for the new account.

Privilege: Select the access rights for the new user.

Manage User

This section lets you change the password and privileges for existing users.

To make changes to a user account, select it from the **User name** dropdown box, make your changes, then click **Modify**.

To delete a user account, select it from the **User name** dropdown box, then click **Delete**.

The screenshot displays the 'User Settings' web interface. It is divided into three main sections:

- Admin Password Setup:** Contains two password input fields labeled 'Password:' and 'Confirm password:', both filled with dots. A 'Save' button is located below the fields.
- Add User Account:** Contains a 'User name:' field with the value 'Carrie', a 'Password:' field with dots, and a 'Confirm password:' field with dots. Below these are three radio button options for 'Privilege': 'Administrator', 'Normal user', and 'Guest'. An 'Add' button is at the bottom.
- Manage User:** Contains a 'User name:' dropdown menu showing 'User1', a 'User password:' field with dots, and three radio button options for 'Authentication': 'Administrator', 'Normal user', and 'Guest'. 'Modify' and 'Delete' buttons are at the bottom.

Device Settings

Turn off the LED indicator: Select this option to turn off the LED next to the lens. This allows the camera to be less conspicuous and more discreet.

Camera Name: Enter a name for your camera to help you identify it.

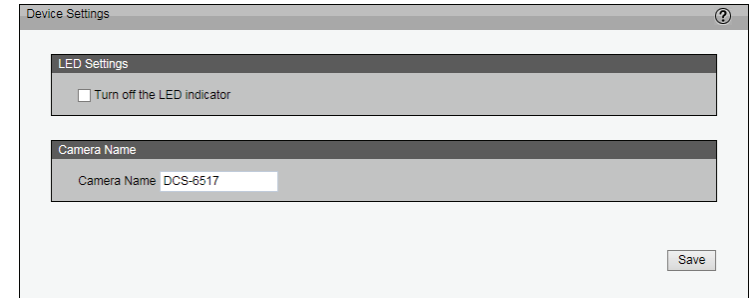

The screenshot shows a web browser window titled "Device Settings" with a help icon in the top right corner. The interface is divided into two main sections. The first section, titled "LED Settings", contains a single checkbox labeled "Turn off the LED indicator", which is currently unchecked. The second section, titled "Camera Name", contains a text input field with the label "Camera Name" and the value "DCS-6517". A "Save" button is located in the bottom right corner of the form area.

Time and Date

This section allows you to automatically or manually configure, update, and maintain the internal system clock for your camera.

Current Server Time: Displays the camera's current time.

Time Zone: Select your time zone from the drop-down menu.

Enable Daylight Saving: Select this to enable the daylight saving time (DST). During DST, the system clock moves one hour ahead. To utilize this feature, be sure to first set the time zone of your network camera, then set the starting and ending time to use DST.

Automatic Time Configuration: Enable this feature to set the camera's clock automatically from an NTP server.

NTP Server: Network Time Protocol (NTP) synchronizes the network camera with an Internet time server. Choose the one that is closest to your location.

Update Interval: This sets the time interval for updating the time information from NTP server.

Set the date and time manually: This option allows you to set the time and date manually.

Copy Your Computer's Time Setting: This will set the camera's clock to match the time from your PC.

The screenshot shows the 'Time and Date' configuration window. It is divided into three main sections:

- Time Configuration:** Shows the current server time as '25 Oct 2010 15:18:46'. The time zone is set to 'GMT-05:00 Eastern Time, New York, Toronto'. There is an unchecked checkbox for 'Enable daylight saving'. Below, 'Daylight saving dates' are configured with 'DST start' on Jan 1st at 12 am and 'DST end' on Jan 1st at 12 am, both on Thursdays.
- Automatic time configuration:** Features an unchecked 'Enable' checkbox. The 'NTP server' field is empty, with a '<< Select NTP server' button. The 'Updating interval' is set to 'One hour'.
- Set the Date and Time manually:** Includes dropdown menus for Year (2010), Month (10), Day (25), Hour (15), Minute (18), and Second (46). A 'Copy Your Computer's Time Settings' button is located below these fields.

A 'Save' button is located in the bottom right corner of the window.

Maintenance

This page lets you reboot the camera, restore the camera to the factory default settings, save and restore the camera's configuration, and upgrade the firmware.

Schedule Reboot: This feature allows the camera to perform a scheduled reboot. Select the days and time you want the camera to reboot, then click **Save**. Make sure you have set the camera's clock to the correct date and time before using this feature.

Reboot: Click **Reboot** to reboot the camera, which will take about one minute to complete. When completed, the live video page will be displayed in your browser. A message will be displayed during the reboot process.

If the connection fails after rebooting, manually enter the IP address of the camera in the address field to resume your connection.

Restore to Default: Click **Default** to restore the camera to the factory default settings.

Export setting backup file: Click **Export** to export your camera settings to a file you can save on your computer.

Upload setting backup file: Click **Browse...** to select a camera settings file to upload to the camera. Please make sure that the model and firmware version of your file is same as your camera. If you have set up a fixed IP or other special settings for your device, uploading a camera settings file is not recommended.

Firmware Upgrade: Click **Browse...** to select a firmware file to upload to the camera. Please make sure that the model of the firmware is the same as your camera. This process will take a few minutes to complete, and will reboot the camera automatically.

Note: Do not power off the camera during the upgrade

You can find the latest firmware for your camera on the D-Link website.

The screenshot shows a web interface titled "Maintenance" with a help icon in the top right corner. The interface is divided into several sections, each with a dark header bar and a light content area:

- Schedule Reboot:** Contains a checkbox labeled "Schedule Reboot". Below it are checkboxes for days of the week: Sun, Mon, Tue, Wed, Thu, Fri, Sat. At the bottom, there are two dropdown menus for time selection, labeled "00" and "00", followed by "hh" and "mm" respectively. A "Save" button is on the right.
- Reboot:** Contains a button labeled "Reboot the device" and a "Reboot" button on the right.
- Restore to Default:** Contains a button labeled "Restore all settings to factory default" and a "Default" button on the right.
- Export Files:** Contains a text input field labeled "Export setting backup file" and an "Export" button on the right.
- Upload Files:** Contains a text input field labeled "Upload setting backup file", a "Browse..." button, and an "Upload" button on the right.
- Firmware Upgrade:** Contains a text input field labeled "File path", a "Browse..." button, and an "Upload" button on the right.

Parameter List

The Parameters List page lists all of the camera's parameters in alphabetical order. If you need technical assistance, please provide the information listed on this page.

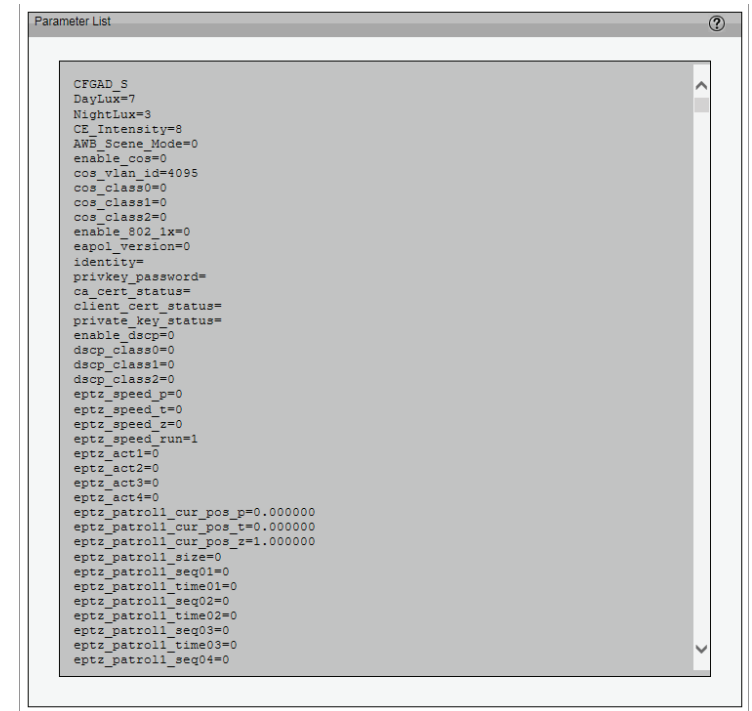

```
Parameter List
CFGAD_S
DayLux=7
NightLux=3
CE_Intensity=8
AWB_Scene_Mode=0
enable_cos=0
cos_vlan_id=4095
cos_class0=0
cos_class1=0
cos_class2=0
enable_802_1x=0
eapol_version=0
identity=
privkey_password=
ca_cert_status=
client_cert_status=
private_key_status=
enable_dscp=0
dscp_class0=0
dscp_class1=0
dscp_class2=0
eptz_speed_p=0
eptz_speed_t=0
eptz_speed_z=0
eptz_speed_run=1
eptz_act1=0
eptz_act2=0
eptz_act3=0
eptz_act4=0
eptz_patroll_cur_pos_p=0.000000
eptz_patroll_cur_pos_t=0.000000
eptz_patroll_cur_pos_z=1.000000
eptz_patroll_size=0
eptz_patroll_seq01=0
eptz_patroll_time01=0
eptz_patroll_seq02=0
eptz_patroll_time02=0
eptz_patroll_seq03=0
eptz_patroll_time03=0
eptz_patroll_seq04=0
```

Logs

This column displays the system log in chronological order. The system log is stored in the camera's buffer and will be overwritten when reaching a certain limit.

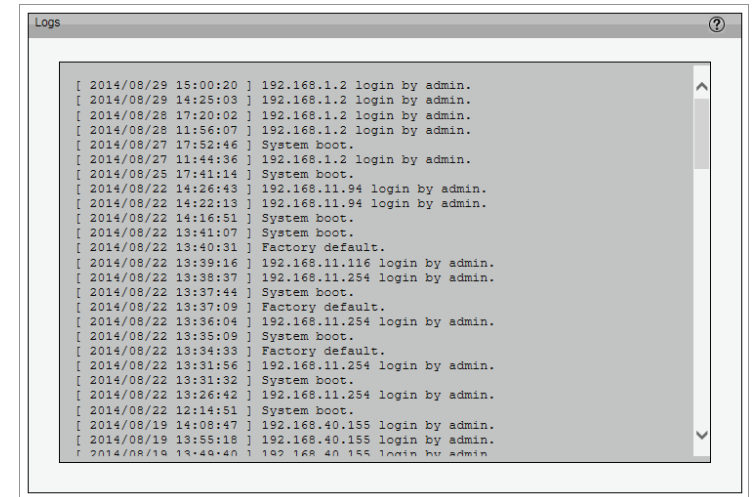

```
Logs
[ 2014/08/29 15:00:20 ] 192.168.1.2 login by admin.
[ 2014/08/29 14:25:03 ] 192.168.1.2 login by admin.
[ 2014/08/28 17:20:02 ] 192.168.1.2 login by admin.
[ 2014/08/28 11:56:07 ] 192.168.1.2 login by admin.
[ 2014/08/27 17:52:46 ] System boot.
[ 2014/08/27 11:44:36 ] 192.168.1.2 login by admin.
[ 2014/08/25 17:41:14 ] System boot.
[ 2014/08/22 14:26:43 ] 192.168.11.94 login by admin.
[ 2014/08/22 14:22:13 ] 192.168.11.94 login by admin.
[ 2014/08/22 14:16:51 ] System boot.
[ 2014/08/22 13:41:07 ] System boot.
[ 2014/08/22 13:40:31 ] Factory default.
[ 2014/08/22 13:39:16 ] 192.168.11.116 login by admin.
[ 2014/08/22 13:38:37 ] 192.168.11.254 login by admin.
[ 2014/08/22 13:37:44 ] System boot.
[ 2014/08/22 13:37:09 ] Factory default.
[ 2014/08/22 13:36:04 ] 192.168.11.254 login by admin.
[ 2014/08/22 13:35:09 ] System boot.
[ 2014/08/22 13:34:33 ] Factory default.
[ 2014/08/22 13:31:56 ] 192.168.11.254 login by admin.
[ 2014/08/22 13:31:32 ] System boot.
[ 2014/08/22 13:26:42 ] 192.168.11.254 login by admin.
[ 2014/08/22 12:14:51 ] System boot.
[ 2014/08/19 14:08:47 ] 192.168.40.155 login by admin.
[ 2014/08/19 13:55:18 ] 192.168.40.155 login by admin.
[ 2014/08/19 13:48:40 ] 192.168.40.155 login by admin.
```

Technical Specifications

Camera		
Camera Hardware Profile	<ul style="list-style-type: none"> • 1/3.2" 5 Megapixel CMOS sensor • 30 meter IR illumination distance • Built-in Infrared-Cut Removable (ICR) Filter module • Minimum illumination: <ul style="list-style-type: none"> • 0.5 lux Color mode • 0.1 lux Black and White mode • 0 lux Black and White mode with IR LED on • Minimum object distance 0.3 m 	<ul style="list-style-type: none"> • 2.8 to 12 mm motorized zoom varifocal DC iris lens • Aperture F1.8 • Angle of view <ul style="list-style-type: none"> • (H) 29.47° to 72.84° • (V) 21.72° to 54.69° • Shutter Speed: 1/2.5 to 1/10,000 • 4x digital zoom
Camera Housing	<ul style="list-style-type: none"> • IP66 compliant weatherproof housing 	<ul style="list-style-type: none"> • Included sunshield
Image Features	<ul style="list-style-type: none"> • Configurable image size, quality, frame rate, and bit rate • Time stamp and text overlays • 3 configurable motion detection windows • Tamper detection 	<ul style="list-style-type: none"> • Configurable privacy mask zones • Configurable exposure, brightness, saturation, contrast, sharpness, white balance, WDR, flip and mirror
Video Compression	<ul style="list-style-type: none"> • Simultaneous H.264/MJPEG format compression • H.264 multicast streaming 	<ul style="list-style-type: none"> • JPEG for still images
Video Resolution	<ul style="list-style-type: none"> • 16:9 1920x1080, 1280x720, 960 x 540 at up to 30 fps 	<ul style="list-style-type: none"> • 4:3 - 2560x1920, 2048x1536, 1600x1200, 1280x960 at up to 15 fps
Audio Support	<ul style="list-style-type: none"> • AAC 	<ul style="list-style-type: none"> • G.711
External Device Interfaces	<ul style="list-style-type: none"> • 10/100 BASE-TX Ethernet port with PoE • 1 DI / 1 DO • Reset button 	<ul style="list-style-type: none"> • Video Out (BNC) • microSD card Slot ¹ • Audio input / output
Network		
Network Protocols	<ul style="list-style-type: none"> • IPv6 • IPv4 • TCP/IP • UDP • ICMP • DHCP client • NTP client (D-Link) • DNS client • DDNS client (D-Link) • SMTP client • FTP client 	<ul style="list-style-type: none"> • HTTP / HTTPS • Samba client • PPPoE • UPnP port forwarding • RTP / RTSP / RTCP • IP filtering • QoS • CoS • Multicast • ONVIF compliant • SNMP
Security	<ul style="list-style-type: none"> • Administrator and user group protection • Remote client access control 	<ul style="list-style-type: none"> • HTTP and RTSP authentication • HTTPS encryption for web access

Appendix A - Technical Specifications

System Management	
System Requirements for Web Interface	<ul style="list-style-type: none"> • Browser: Internet Explorer 7 or higher, Firefox 19 or higher
Event Management	<ul style="list-style-type: none"> • Motion detection • Event notification and uploading of snapshots/video clips via e-mail or FTP • Supports multiple HTTP, SMTP, and FTP servers • Multiple event notifications • Multiple recording methods for easy backup
Remote Management	<ul style="list-style-type: none"> • Take snapshots/video clips and save to local hard drive • Configuration interface accessible via web browser
OS Support (for setup utility)	<ul style="list-style-type: none"> • Operating System: Windows 10/8/7/Vista/XP/2000
D-ViewCam™ System Requirements	<ul style="list-style-type: none"> • Operating System: Windows 10/8/7/Vista/XP/2000 • Web Browser: Internet Explorer 7 or higher • Protocol: Standard TCP/IP
D-ViewCam™ Software Functions	<ul style="list-style-type: none"> • Remote management/control of up to 32 cameras • Supports all management functions provided in web interface • Viewing of up to 32 cameras on one screen • Scheduled motion triggered, or manual recording options
General	
Weight	<ul style="list-style-type: none"> • 1.25 kg (2.75 lbs) for camera only, without sunshield and mounting bracket
Power	<ul style="list-style-type: none"> • External power adapter: 12 V DC 1.5 A. 50/60 Hz • PoE: IEEE 802.3af Class 0
Power Consumption	<ul style="list-style-type: none"> • Max:12.48 W
Temperature	<ul style="list-style-type: none"> • Operating: -40 to 50 °C (-40 to 122 °F) • Storage: -20 to 70 °C (-4 to 158 °F)
Humidity	<ul style="list-style-type: none"> • Operating: 20% to 80% non-condensing • Storage: 5% to 95% non-condensing
Certifications	<ul style="list-style-type: none"> • CE • CE LVD • ICES-003 • FCC • C-Tick
Dimensions	<p>Technical drawings of the D-Link DCS-7517 camera showing dimensions. The top view shows a diameter of Ø110 and a lens diameter of Ø83. The side view shows a height of 135.59 and a width of 290.34.</p>

¹ SD/SDHC/SDXC v3.01 compatible

Regulatory Information

Federal Communication Commission Interference Statement

This equipment has been tested and found to comply with the limits for a Class A digital device, pursuant to part 15 of the FCC Rules. These limits are designed to provide reasonable protection against harmful interference when the equipment is operated in a commercial environment. This equipment generates, uses, and can radiate radio frequency energy and, if not installed and used in accordance with the instruction manual, may cause harmful interference to radio communications. Operation of this equipment in a residential area is likely to cause harmful interference in which case the user will be required to correct the interference at his own expense.

Non-modification Statement

Any changes or modifications not expressly approved by the party responsible for compliance could void the user's authority to operate the equipment.

Caution

This device complies with Part 15 of the FCC Rules. Operation is subject to the following two conditions:

(1) This device may not cause harmful interference, and (2) this device must accept any interference received, including interference that may cause undesired operation.

Innovation, Science and Economic Development Canada (ISED) Statement:

This Class A digital apparatus complies with Canadian ICES-003.

Cet appareil numérique de la classe A est conforme à la norme NMB-003 du Canada.

CE EMI Class A Warning

This equipment is compliant with Class A of CISPR 32. In a residential environment this equipment may cause radio interference.

SAFETY INSTRUCTIONS

The following general safety guidelines are provided to help ensure your own personal safety and protect your product from potential damage. Remember to consult the product user instructions for more details.

- Static electricity can be harmful to electronic components. Discharge static electricity from your body (i.e. touching grounded bare metal) before touching the product.
- Do not attempt to service the product and never disassemble the product. For some products with a user replaceable battery, please read and follow the instructions in the user manual.
- Do not spill food or liquid on your product and never push any objects into the openings of your product.
- Do not use this product near water, areas with high humidity, or condensation unless the product is specifically rated for outdoor application.
- Keep the product away from radiators and other heat sources.
- Always unplug the product from mains power before cleaning and use a dry lint free cloth only.

SICHERHEITSVORSCHRIFTEN

Die folgenden allgemeinen Sicherheitsvorschriften dienen als Hilfe zur Gewährleistung Ihrer eigenen Sicherheit und zum Schutz Ihres Produkts. Weitere Details finden Sie in den Benutzeranleitungen zum Produkt.

- Statische Elektrizität kann elektronischen Komponenten schaden. Um Schäden durch statische Aufladung zu vermeiden, leiten Sie elektrostatische Ladungen von Ihrem Körper ab, (z. B. durch Berühren eines geerdeten blanken Metallteils), bevor Sie das Produkt berühren.
- Unterlassen Sie jeden Versuch, das Produkt zu warten, und versuchen Sie nicht, es in seine Bestandteile zu zerlegen. Für einige Produkte mit austauschbaren Akkus lesen Sie bitte das Benutzerhandbuch und befolgen Sie die dort beschriebenen Anleitungen.
- Vermeiden Sie, dass Speisen oder Flüssigkeiten auf Ihr Produkt gelangen, und stecken Sie keine Gegenstände in die Gehäuseschlitze oder -öffnungen Ihres Produkts.
- Verwenden Sie dieses Produkt nicht in unmittelbarer Nähe von Wasser und nicht in Bereichen mit hoher Luftfeuchtigkeit oder Kondensation, es sei denn, es ist speziell zur Nutzung in Außenbereichen vorgesehen und eingestuft.
- Halten Sie das Produkt von Heizkörpern und anderen Quellen fern, die Wärme erzeugen.
- Trennen Sie das Produkt immer von der Stromzufuhr, bevor Sie es reinigen und verwenden Sie dazu ausschließlich ein trockenes fusselfreies Tuch.

CONSIGNES DE SÉCURITÉ

Les consignes générales de sécurité ci-après sont fournies afin d'assurer votre sécurité personnelle et de protéger le produit d'éventuels dommages. Veuillez consulter les consignes d'utilisation du produit pour plus de détails.

- L'électricité statique peut endommager les composants électroniques. Déchargez l'électricité statique de votre corps (en touchant un objet en métal relié à la terre par exemple) avant de toucher le produit.
- N'essayez pas d'intervenir sur le produit et ne le démontez jamais. Pour certains produits contenant une batterie remplaçable par l'utilisateur, veuillez lire et suivre les consignes contenues dans le manuel d'utilisation.
- Ne renversez pas d'aliments ou de liquide sur le produit et n'insérez jamais d'objets dans les orifices.
- N'utilisez pas ce produit à proximité d'un point d'eau, de zones très humides ou de condensation sauf si le produit a été spécifiquement conçu pour une application extérieure.
- Éloignez le produit des radiateurs et autres sources de chaleur.
- Débranchez toujours le produit de l'alimentation avant de le nettoyer et utilisez uniquement un chiffon sec non pelucheux.

INSTRUCCIONES DE SEGURIDAD

Las siguientes directrices de seguridad general se facilitan para ayudarle a garantizar su propia seguridad personal y para proteger el producto frente a posibles daños. No olvide consultar las instrucciones del usuario del producto para obtener más información.

- La electricidad estática puede resultar nociva para los componentes electrónicos. Descargue la electricidad estática de su cuerpo (p. ej., tocando algún metal sin revestimiento conectado a tierra) antes de tocar el producto.
- No intente realizar el mantenimiento del producto ni lo desmonte nunca. Para algunos productos con batería reemplazable por el usuario, lea y siga las instrucciones del manual de usuario.
- No derrame comida o líquidos sobre el producto y nunca deje que caigan objetos en las aberturas del mismo.
- No utilice este producto cerca del agua, en zonas con humedad o condensación elevadas a menos que el producto esté clasificado específicamente para aplicación en exteriores.
- Mantenga el producto alejado de los radiadores y de otras fuentes de calor.
- Desenchufe siempre el producto de la alimentación de red antes de limpiarlo y utilice solo un paño seco sin pelusa.

ISTRUZIONI PER LA SICUREZZA

Le seguenti linee guida sulla sicurezza sono fornite per contribuire a garantire la sicurezza personale degli utenti e a proteggere il prodotto da potenziali danni. Per maggiori dettagli, consultare le istruzioni per l'utente del prodotto.

- L'elettricità statica può essere pericolosa per i componenti elettronici. Scaricare l'elettricità statica dal corpo (ad esempio toccando una parte metallica collegata a terra) prima di toccare il prodotto.
- Non cercare di riparare il prodotto e non smontarlo mai. Per alcuni prodotti dotati di batteria sostituibile dall'utente, leggere e seguire le istruzioni riportate nel manuale dell'utente.
- Non versare cibi o liquidi sul prodotto e non spingere mai alcun oggetto nelle aperture del prodotto.
- Non usare questo prodotto vicino all'acqua, in aree con elevato grado di umidità o soggette a condensa a meno che il prodotto non sia specificatamente approvato per uso in ambienti esterni.
- Tenere il prodotto lontano da caloriferi e altre fonti di calore.
- Scollegare sempre il prodotto dalla presa elettrica prima di pulirlo e usare solo un panno asciutto che non lasci filacce.

VEILIGHEIDSINFORMATIE

De volgende algemene veiligheidsinformatie werd verstrekt om uw eigen persoonlijke veiligheid te waarborgen en uw product te beschermen tegen mogelijke schade. Denk eraan om de gebruikersinstructies van het product te raadplegen voor meer informatie.

- Statische elektriciteit kan schadelijk zijn voor elektronische componenten. Ontlaad de statische elektriciteit van uw lichaam (d.w.z. het aanraken van geaard bloot metaal) voordat u het product aanraakt.
- U mag nooit proberen het product te onderhouden en u mag het product nooit demonteren. Voor sommige producten met door de gebruiker te vervangen batterij, dient u de instructies in de gebruikershandleiding te lezen en te volgen.
- Mors geen voedsel of vloeistof op uw product en u mag nooit voorwerpen in de openingen van uw product duwen.
- Gebruik dit product niet in de buurt van water, gebieden met hoge vochtigheid of condensatie, tenzij het product specifiek geclassificeerd is voor gebruik buitenshuis.
- Houd het product uit de buurt van radiators en andere warmtebronnen.
- U dient het product steeds los te koppelen van de stroom voordat u het reinigt en gebruik uitsluitend een droge pluisvrije doek.

Disposing and Recycling Your Product

ENGLISH

EN



This symbol on the product or packaging means that according to local laws and regulations this product should be not be disposed of in household waste but sent for recycling. Please take it to a collection point designated by your local authorities once it has reached the end of its life, some will accept products for free. By recycling the product and its packaging in this manner you help to conserve the environment and protect human health.

D-Link and the Environment

At D-Link, we understand and are committed to reducing any impact our operations and products may have on the environment. To minimise this impact D-Link designs and builds its products to be as environmentally friendly as possible, by using recyclable, low toxic materials in both products and packaging.

D-Link recommends that you always switch off or unplug your D-Link products when they are not in use. By doing so you will help to save energy and reduce CO2 emissions.

To learn more about our environmentally responsible products and packaging please visit www.dlinkgreen.com.

DEUTSCH

DE



Dieses Symbol auf dem Produkt oder der Verpackung weist darauf hin, dass dieses Produkt gemäß bestehender örtlicher Gesetze und Vorschriften nicht über den normalen Hausmüll entsorgt werden sollte, sondern einer Wiederverwertung zuzuführen ist. Bringen Sie es bitte zu einer von Ihrer Kommunalbehörde entsprechend amtlich ausgewiesenen Sammelstelle, sobald das Produkt das Ende seiner Nutzungsdauer erreicht hat. Für die Annahme solcher Produkte erheben einige dieser Stellen keine Gebühren. Durch ein auf diese Weise durchgeführtes Recycling des Produkts und seiner Verpackung helfen Sie, die Umwelt zu schonen und die menschliche Gesundheit zu schützen.

D-Link und die Umwelt

D-Link ist sich den möglichen Auswirkungen seiner Geschäftstätigkeiten und seiner Produkte auf die Umwelt bewusst und fühlt sich verpflichtet, diese entsprechend zu mindern. Zu diesem Zweck entwickelt und stellt D-Link seine Produkte mit dem Ziel größtmöglicher Umweltfreundlichkeit her und verwendet wiederverwertbare, schadstoffarme Materialien bei Produktherstellung und Verpackung.

D-Link empfiehlt, Ihre Produkte von D-Link, wenn nicht in Gebrauch, immer auszuschalten oder vom Netz zu nehmen. Auf diese Weise helfen Sie, Energie zu sparen und CO2-Emissionen zu reduzieren.

Wenn Sie mehr über unsere umweltgerechten Produkte und Verpackungen wissen möchten, finden Sie entsprechende Informationen im Internet unter www.dlinkgreen.com.

FRANÇAIS

FR



Ce symbole apposé sur le produit ou son emballage signifie que, conformément aux lois et réglementations locales, ce produit ne doit pas être éliminé avec les déchets domestiques mais recyclé. Veuillez le rapporter à un point de collecte prévu à cet effet par les autorités locales; certains accepteront vos produits gratuitement. En recyclant le produit et son emballage de cette manière, vous aidez à préserver l'environnement et à protéger la santé de l'homme.

D-Link et l'environnement

Chez D-Link, nous sommes conscients de l'impact de nos opérations et produits sur l'environnement et nous engageons à le réduire. Pour limiter cet impact, D-Link conçoit et fabrique ses produits de manière aussi écologique que possible, en utilisant des matériaux recyclables et faiblement toxiques, tant dans ses produits que ses emballages.

D-Link recommande de toujours éteindre ou débrancher vos produits D-Link lorsque vous ne les utilisez pas. Vous réaliserez ainsi des économies d'énergie et réduirez vos émissions de CO2.

Pour en savoir plus sur les produits et emballages respectueux de l'environnement, veuillez consulter le www.dlinkgreen.com.

ESPAÑOL

ES



Este símbolo en el producto o el embalaje significa que, de acuerdo con la legislación y la normativa local, este producto no se debe desechar en la basura doméstica sino que se debe reciclar. Llévelo a un punto de recogida designado por las autoridades locales una vez que ha llegado al fin de su vida útil; algunos de ellos aceptan recogerlos de forma gratuita. Al reciclar el producto y su embalaje de esta forma, contribuye a preservar el medio ambiente y a proteger la salud de los seres humanos.

D-Link y el medio ambiente

En D-Link, comprendemos y estamos comprometidos con la reducción del impacto que puedan tener nuestras actividades y nuestros productos en el medio ambiente. Para reducir este impacto, D-Link diseña y fabrica sus productos para que sean lo más ecológicos posible, utilizando materiales reciclables y de baja toxicidad tanto en los productos como en el embalaje.

D-Link recomienda apagar o desenchufar los productos D-Link cuando no se estén utilizando. Al hacerlo, contribuirá a ahorrar energía y a reducir las emisiones de CO2.

Para obtener más información acerca de nuestros productos y embalajes ecológicos, visite el sitio www.dlinkgreen.com.

ITALIANO**IT**

La presenza di questo simbolo sul prodotto o sulla confezione del prodotto indica che, in conformità alle leggi e alle normative locali, questo prodotto non deve essere smaltito nei rifiuti domestici, ma avviato al riciclo. Una volta terminato il ciclo di vita utile, portare il prodotto presso un punto di raccolta indicato dalle autorità locali. Alcuni questi punti di raccolta accettano gratuitamente i prodotti da riciclare. Scegliendo di riciclare il prodotto e il relativo imballaggio, si contribuirà a preservare l'ambiente e a salvaguardare la salute umana.

D-Link e l'ambiente

D-Link cerca da sempre di ridurre l'impatto ambientale dei propri stabilimenti e dei propri prodotti. Allo scopo di ridurre al minimo tale impatto, D-Link progetta e realizza i propri prodotti in modo che rispettino il più possibile l'ambiente, utilizzando materiali riciclabili a basso tasso di tossicità sia per i prodotti che per gli imballaggi.

D-Link raccomanda di spegnere sempre i prodotti D-Link o di scollegarne la spina quando non vengono utilizzati. In questo modo si contribuirà a risparmiare energia e a ridurre le emissioni di anidride carbonica.

Per ulteriori informazioni sui prodotti e sugli imballaggi D-Link a ridotto impatto ambientale, visitate il sito all'indirizzo www.dlinkgreen.com.

NEDERLANDS**NL**

Dit symbool op het product of de verpakking betekent dat dit product volgens de plaatselijke wetgeving niet mag worden weggegooid met het huishoudelijk afval, maar voor recyclage moeten worden ingeleverd. Zodra het product het einde van de levensduur heeft bereikt, dient u het naar een inzamelpunt te brengen dat hiertoe werd aangeduid door uw plaatselijke autoriteiten, sommige autoriteiten accepteren producten zonder dat u hiervoor dient te betalen. Door het product en de verpakking op deze manier te recyclen helpt u het milieu en de gezondheid van de mens te beschermen.

D-Link en het milieu

Bij D-Link spannen we ons in om de impact van onze handelingen en producten op het milieu te beperken. Om deze impact te beperken, ontwerpt en bouwt D-Link zijn producten zo milieuvriendelijk mogelijk, door het gebruik van recycleerbare producten met lage toxiciteit in product en verpakking.

D-Link raadt aan om steeds uw D-Link producten uit te schakelen of uit de stekker te halen wanneer u ze niet gebruikt. Door dit te doen bespaart u energie en beperkt u de CO₂-emissies.

Breng een bezoek aan www.dlinkgreen.com voor meer informatie over onze milieuverantwoorde producten en verpakkingen.

POLSKI**PL**

Ten symbol umieszczony na produkcie lub opakowaniu oznacza, że zgodnie z miejscowym prawem i lokalnymi przepisami niniejszego produktu nie wolno wyrzucać jak odpady czy śmieci z gospodarstwa domowego, lecz należy go poddać procesowi recyklingu. Po zakończeniu użytkowania produktu, niektóre odpowiednie do tego celu podmioty przyjmą takie produkty nieodpłatnie, dlatego prosimy dostarczyć go do punktu zbiórki wskazanego przez lokalne władze. Poprzez proces recyklingu i dzięki takiemu postępowaniu z produktem oraz jego opakowaniem, pomogą Państwo chronić środowisko naturalne i dbać o ludzkie zdrowie.

D-Link i środowisko

D-Link podchodzimy w sposób świadomy do ochrony otoczenia oraz jesteśmy zaangażowani w zmniejszanie wpływu naszych działań i produktów na środowisko naturalne. W celu zminimalizowania takiego wpływu firma D-Link konstruuje i wytwarza swoje produkty w taki sposób, aby były one jak najbardziej przyjazne środowisku, stosując do tych celów materiały nadające się do powtórnego wykorzystania, charakteryzujące się małą toksycznością zarówno w przypadku samych produktów jak i opakowań.

Firma D-Link zaleca, aby Państwo zawsze prawidłowo wyłączali z użytku swoje produkty D-Link, gdy nie są one wykorzystywane. Postępując w ten sposób pozwalają Państwo oszczędzać energię i zmniejszać emisje CO₂.

Aby dowiedzieć się więcej na temat produktów i opakowań mających wpływ na środowisko prosimy zapoznać się ze stroną Internetową www.dlinkgreen.com.

ČESKY**CZ**

Tento symbol na výrobku nebo jeho obalu znamená, že podle místně platných předpisů se výrobek nesmí vyhazovat do komunálního odpadu, ale odeslat k recyklaci. Až výrobek doslouží, odnese jej prosím na sběrné místo určené místními úřady k tomuto účelu. Někteřá sběrná místa přijímají výrobky zdarma. Recyklací výrobku i obalu pomáháte chránit životní prostředí i lidské zdraví.

D-Link a životní prostředí

Ve společnosti D-Link jsme si vědomi vlivu našich provozů a výrobků na životní prostředí a snažíme se o minimalizaci těchto vlivů. Proto své výrobky navrhujeme a vyrábíme tak, aby byly co nejekologičtější, a ve výrobcích i obalech používáme recyklovatelné a nízkotoxické materiály.

Společnost D-Link doporučuje, abyste své výrobky značky D-Link vypnuli nebo vytáhli ze zásuvky vždy, když je nepoužíváte. Pomůžete tak šetřit energii a snížit emise CO₂.

Více informací o našich ekologických výrobcích a obalech najdete na adrese www.dlinkgreen.com.

MAGYAR**HU**

Ez a szimbólum a terméken vagy a csomagoláson azt jelenti, hogy a helyi törvényeknek és szabályoknak megfelelően ez a termék nem semmisíthető meg a háztartási hulladékkal együtt, hanem újrahasznosításra kell küldeni. Kérjük, hogy a termék élettartamának elteltét követően vigye azt a helyi hatóság által kijelölt gyűjtőhelyre. A termékek egyes helyeken ingyen elhelyezhetők. A termék és a csomagolás újrahasznosításával segíti védeni a környezetet és az emberek egészségét.

A D-Link és a környezet

A D-Linknél megértjük és elköteleztük magunkat a műveleteink és termékeink környezetre gyakorolt hatásainak csökkentésére. Az ezen hatás csökkentése érdekében a D-Link a lehető leginkább környezetbarát termékeket tervez és gyárt azáltal, hogy újrahasznosítható, alacsony károsanyag-tartalmú termékeket gyárt és csomagolásokat alkalmaz.

A D-Link azt javasolja, hogy mindig kapcsolja ki vagy húzza ki a D-Link termékeket a tápforrásból, ha nem használja azokat. Ezzel segít az energia megtakarításában és a széndioxid kibocsátásának csökkentésében.

Környezetbarát termékeinkről és csomagolásainkról további információkat a www.dlinkgreen.com weboldalon tudhat meg.

NORSK**NO**

Dette symbolet på produktet eller forpakningen betyr at dette produktet ifølge lokale lover og forskrifter ikke skal kastes sammen med husholdningsavfall, men leveres inn til gjenvinning. Vennligst ta det til et innsamlingssted anvist av lokale myndigheter når det er kommet til slutten av levetiden. Noen steder aksepteres produkter uten avgift. Ved på denne måten å gjenvinne produktet og forpakningen hjelper du å verne miljøet og beskytte folks helse.

D-Link og miljøet

Hos D-Link forstår vi oss på og er forpliktet til å minske innvirkningen som vår drift og våre produkter kan ha på miljøet. For å minimalisere denne innvirkningen designer og lager D-Link produkter som er så miljøvennlig som mulig, ved å bruke resirkulerbare, lav-toksiske materialer både i produktene og forpakningen.

D-Link anbefaler at du alltid slår av eller frakobler D-Link-produkter når de ikke er i bruk. Ved å gjøre dette hjelper du å spare energi og å redusere CO2-utslipp.

For mer informasjon angående våre miljøansvarlige produkter og forpakninger kan du gå til www.dlinkgreen.com.

DANSK**DK**

Dette symbol på produktet eller emballagen betyder, at dette produkt i henhold til lokale love og regler ikke må bortskaffes som husholdningsaffald, mens skal sendes til genbrug. Indlever produktet til et indsamlingssted som angivet af de lokale myndigheder, når det er nået til slutningen af dets levetid. I nogle tilfælde vil produktet blive modtaget gratis. Ved at indlevere produktet og dets emballage til genbrug på denne måde bidrager du til at beskytte miljøet og den menneskelige sundhed.

D-Link og miljøet

Hos D-Link forstår vi og bestræber os på at reducere enhver indvirkning, som vores aktiviteter og produkter kan have på miljøet. For at minimere denne indvirkning designer og producerer D-Link sine produkter, så de er så miljøvenlige som muligt, ved at bruge genanvendelige materialer med lavt giftighedsniveau i både produkter og emballage.

D-Link anbefaler, at du altid slukker eller frakobler dine D-Link-produkter, når de ikke er i brug. Ved at gøre det bidrager du til at spare energi og reducere CO₂-udledningerne.

Du kan finde flere oplysninger om vores miljømæssigt ansvarlige produkter og emballage på www.dlinkgreen.com.

SUOMI**FI**

Tämä symboli tuotteen pakkauksessa tarkoittaa, että paikallisten lakien ja säännösten mukaisesti tätä tuotetta ei pidä hävittää yleisen kotitalousjätteen seassa vaan se tulee toimittaa kierrätettäväksi. Kun tuote on elinkaarensa päässä, toimita se lähimpään viranomaisten hyväksymään kierrätyspisteeseen. Kierrättämällä käytetyn tuotteen ja sen pakkauksen autat tukemaan sekä ympäristön että ihmisten terveyttä ja hyvinvointia.

D-Link ja ympäristö

D-Link ymmärtää ympäristönsuojelun tärkeyden ja on sitoutunut vähentämään tuotteistaan ja niiden valmistuksesta ympäristölle mahdollisesti aiheutuvia haittavaikutuksia. Nämä negatiiviset vaikutukset minimoidakseen D-Link suunnittelee ja valmistaa tuotteensa mahdollisimman ympäristöystävällisiksi käyttämällä kierrätettäviä, alhaisia pitoisuuksia haitallisia aineita sisältäviä materiaaleja sekä tuotteissaan että niiden pakkauksissa.

Suosittellemme, että irrotat D-Link-tuotteesi virtalähteestä tai sammutat ne aina, kun ne eivät ole käytössä. Toimimalla näin autat säästämään energiaa ja vähentämään hiilidioksiidipäästöjä.

Lue lisää ympäristöystävällisistä D-Link-tuotteista ja pakkauksistamme osoitteesta www.dlinkgreen.com.

SVENSKA

SE



Den här symbolen på produkten eller förpackningen betyder att produkten enligt lokala lagar och föreskrifter inte skall kastas i hushållssoporna utan i stället återvinnas. Ta den vid slutet av dess livslängd till en av din lokala myndighet utsedd uppsamlingsplats, vissa accepterar produkter utan kostnad. Genom att på detta sätt återvinna produkten och förpackningen hjälper du till att bevara miljön och skydda människors hälsa.

D-Link och miljön

På D-Link förstår vi och är fast beslutna att minska den påverkan våra verksamheter och produkter kan ha på miljön. För att minska denna påverkan utformar och bygger D-Link sina produkter för att de ska vara så miljövänliga som möjligt, genom att använda återvinningsbara material med låg gifthalt i både produkter och förpackningar.

D-Link rekommenderar att du alltid stänger av eller kopplar ur dina D-Link produkter när du inte använder dem. Genom att göra detta hjälper du till att spara energi och minska utsläpp av koldioxid.

För mer information om våra miljöansvariga produkter och förpackningar www.dlinkgreen.com.

PORTUGUÊS

PT



Este símbolo no produto ou embalagem significa que, de acordo com as leis e regulamentações locais, este produto não deverá ser eliminado juntamente com o lixo doméstico mas enviado para a reciclagem. Transporte-o para um ponto de recolha designado pelas suas autoridades locais quando este tiver atingido o fim da sua vida útil, alguns destes pontos aceitam produtos gratuitamente. Ao reciclar o produto e respectiva embalagem desta forma, ajuda a preservar o ambiente e protege a saúde humana.

A D-Link e o ambiente

Na D-Link compreendemos e comprometemo-nos com a redução do impacto que as nossas operações e produtos possam ter no ambiente. Para minimizar este impacto a D-Link concebe e constrói os seus produtos para que estes sejam o mais inofensivos para o ambiente possível, utilizando materiais recicláveis e não tóxicos tanto nos produtos como nas embalagens.

A D-Link recomenda que desligue os seus produtos D-Link quando estes não se encontrarem em utilização. Com esta acção ajudará a poupar energia e reduzir as emissões de CO₂.

Para saber mais sobre os nossos produtos e embalagens responsáveis a nível ambiental visite www.dlinkgreen.com.